

NLC Strategy – Design and Technology

M. Ross
3/25/99

What demonstrations are required for NLC design?

SLC many Engineering and Operational aspects:
Stabilization
e+
Damping ring
Collimation
Feedback
Profile monitoring

FFTB sub 100nm beams
NLCTA loading compensation; X-band linac
ATF Injector/Damping ring
ASSET transverse wakes in X-band structures
Collimator Wake transverse wakes in collimator jaws

Key technologies:

Goals
Method
Problems

Pulsed machine stabilization:

Band	Source
Machine rate- Full rate	Pulse to pulse stabilization – full repetition rate (trigger system, beam dynamics, pulsed device performance)
0.1 to 10 Hz mid-range	Microphonic/power supply stabilization –
1 to 0.1 /minute slow	Thermal stabilization – water/airconditioning controller instabilities –
daily/seasonal very slow	Thermal stabilization – outdoor temperature –
step	Operator action, mechanical
1/100-10000 pulses - fliers	Error pulses – misfires/arcings/breakdown

120 Hz to 1 /year

Design process:

- 1) tolerance budget and table – start from end user requirements on σ_I/I , σ_x , σ_E
- 2) diagnostic tools that meet the requirements of the table
- 3) address at least one of the above frequency bands
- 4) Include feedback in the tolerance table; primarily for slow drifts.
- 5) Develop controls philosophy with regard to “operator tuning” and control system feedback
- 6) Use of ‘orthogonal control’ emphasizing correlation between devices in terms of both performance and effect

Software (most important)	Bands affected
HISTORY RECORD to track changes and device	Slow-step
FRONT END MONITORS Record phase and amplitude monitors [actual beam fields], DAC and position settings (phase shifters)[device controllers], adjustments [operator]	step
Comprehensive ERROR AND EVENT LOGGER	step
Driven CORRELATION PLOTS cause and effect tools	
FEEDBACK –tie any two knobs and sensors together; (low to moderate bandwidth) Especially phase, amplitude and energy feedback.	All except fliers and full
Log and RECORD FEEDBACK PERFORMANCE – controller behavior, feedback bandwidth and residual error signal noise and error events.	Full +
SYNCHRONIZED DATA ACQUISITION integrated with correlation plot	Full + fliers
BPM AND PULSED DEVICE READINGS ON EVERY MACHINE PULSE – long term data with statistical (rms) and FFT analysis Cause and effect vs rms. Fitting in order to orthogonalize / separate sources. Filtering to find narrow band sources – usually microphonic	All esp. fliers

Hardware

- 1) Use of PRIMARY MONITOR CIRCUITS for phase and amplitude (or magnet current). No control based on DAC or transducer position.
- 2) Beam position monitor pairs located for ENERGY FEEDBACK ($\eta_1=\eta_2$; $\beta_1=\beta_2$; $\Delta\phi=\pi$)
- 3) Performance requirements based on tolerance budget
- 4) Use data from software based feedback to develop stabilization improvement projects and priorities.
- 5) REDUNDANCY for critical phase monitors – phase monitoring loops in injector systems
- 6) Trigger system performance tests

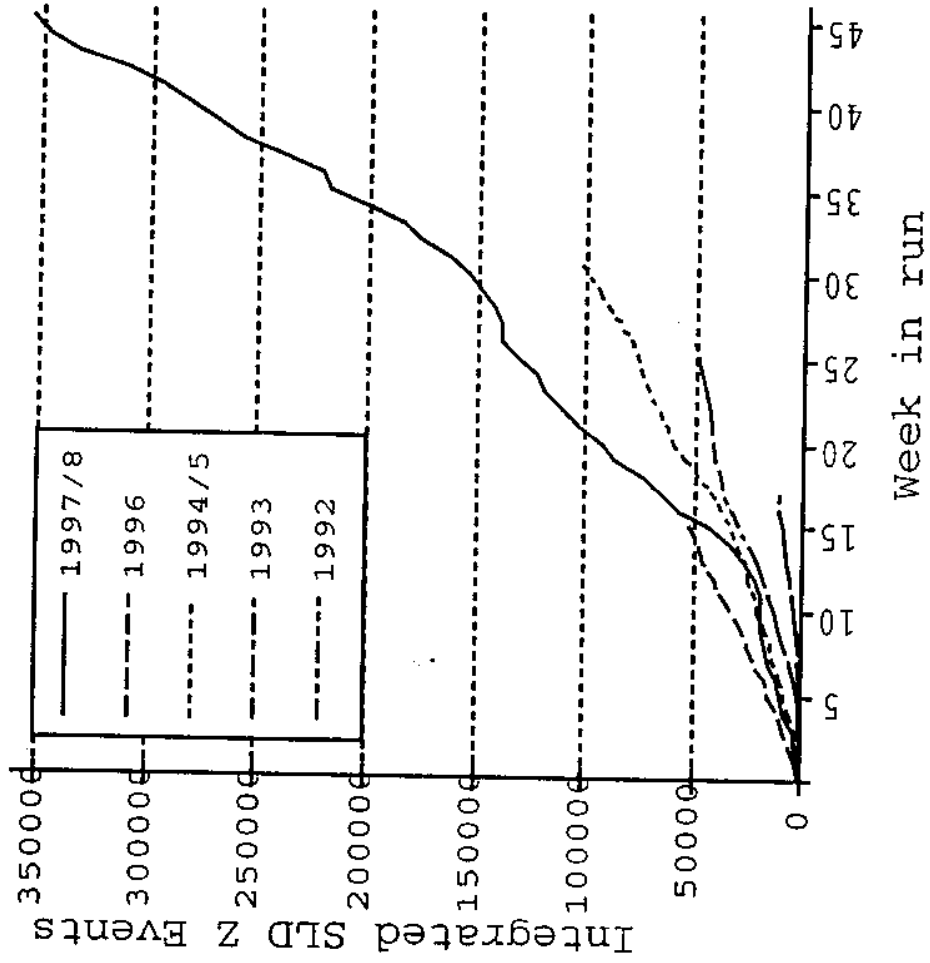
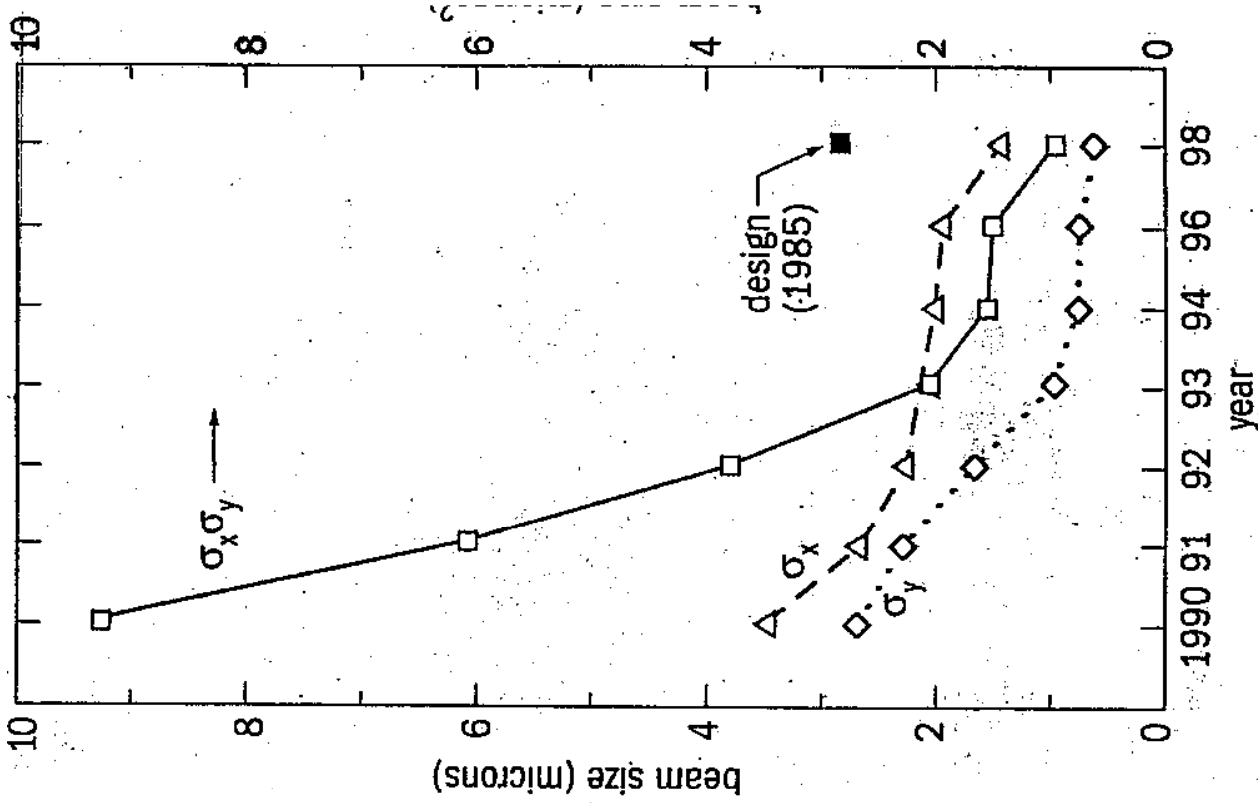

SLC

PERFORMANCE

1992-1998

How did SLC operation use these tools to advantage?

Luminosity reached $\frac{1}{2}$ design before target failure 6/98
(just 2 weeks before scheduled end of final run)

	Predicted parameters	Actual parameters at peak
N	7.5×10^{10}	4×10^{10}
$\sigma_x \sigma_y$	$3 \times 3 \mu\text{m}$	$1.5 \times .7 \mu\text{m}$
L	6×10^{30}	3×10^{30}

Smaller beam sizes \rightarrow

tighter tolerances

better understanding of emittance propagation

better phase space monitoring

feedback

Reduced intensity \rightarrow

source (pol e- and e+)

ring limitations (instabilities and RF)

bunch compression

Pulse to pulse instabilities – jitter –

Primarily → Intensity and Trajectory

Intensity jitter requirement based on:
beam loading ↔ energy stability

Trajectory jitter requirement based on:
Luminosity overlap

Effective time averaged ‘emittance’

Units of σ

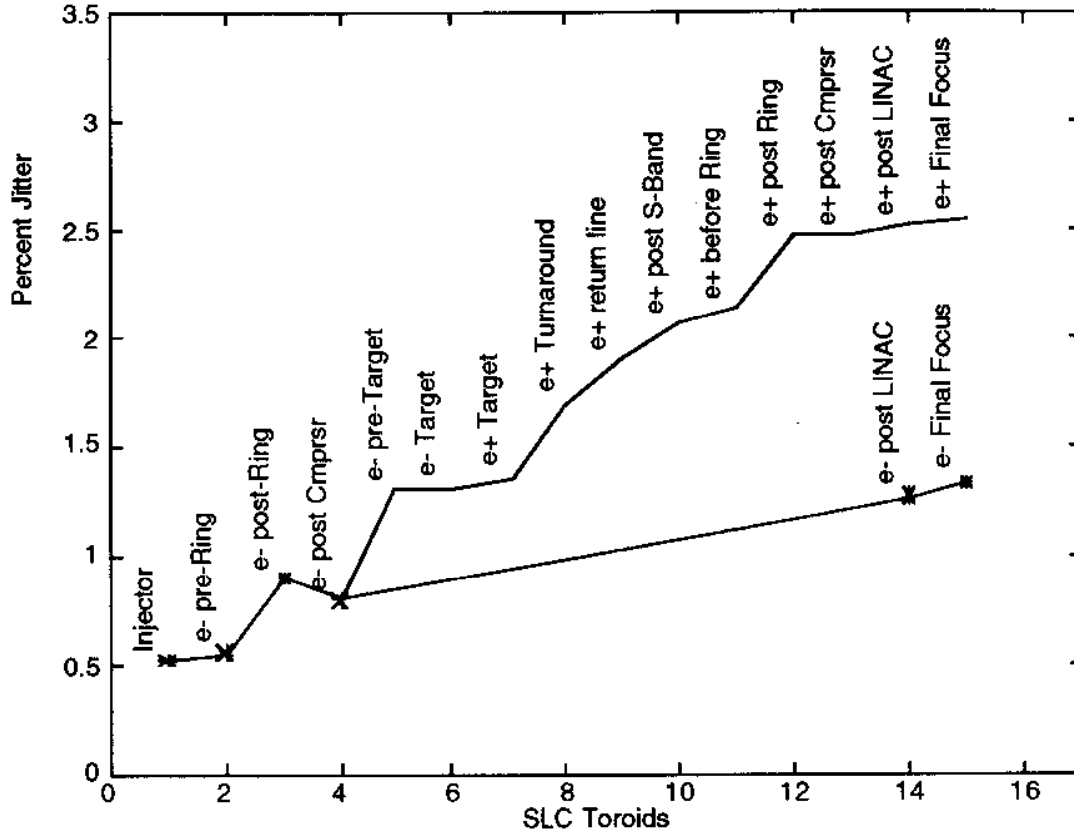

SLC Intensity 'jitter' σ_I/I
 VS
 location \rightarrow 5 second RMS
 ~ 600 pulses

Emittance and Jitter Budgets

Preliminary ILC Emittance Budget.

	A	B	C
$\gamma\epsilon_x/\gamma\epsilon_y$ from DR [10^{-8}]	300 / 3		
$\Delta\epsilon_x/\Delta\epsilon_y$ in source (10 GeV) [%]	0 / 0	20 / 50	40 / 80
$\Delta\epsilon_x/\Delta\epsilon_y$ in linacs [%]	20 / 60	20 / 130	30 / 200
$\Delta\epsilon_x/\Delta\epsilon_y$ in beam delivery [%]	10 / 40	20 / 50	30 / 80
$\gamma\epsilon_x/\gamma\epsilon_y$ at IP [10^{-8}]	400 / 6	500 / 10	600 / 14

Preliminary ILC Jitter Budget. — TRAJECTORY

$\Delta X/\Delta Y$ in source (10 GeV) [a]	0.20 / 0.20
$\Delta X/\Delta Y$ in linacs [σ]	0 / 0.35
$\Delta X/\Delta Y$ in beam delivery [a]	xl.25 / xl.25 and 0.25
$\Delta X/\Delta Y$ in final doublet [σ]	0 / 0.25
Total $\Delta X/\Delta Y$ at IP [σ]	0.25 / 0.60

Collimators
amplitude jitter

- All requirements are tighter than ZDR (except case C in X)
- Linac tolerances are roughly constant across cases – dominated by structure alignment errors
- Case A has very tight BD requirements but luminosity is also quite large — *balance as nec.*
- Jitter budget needs to be re-distributed based on “realistic” ground motion models and IP stabilization and feedback – most vibration limits are tightest in case A

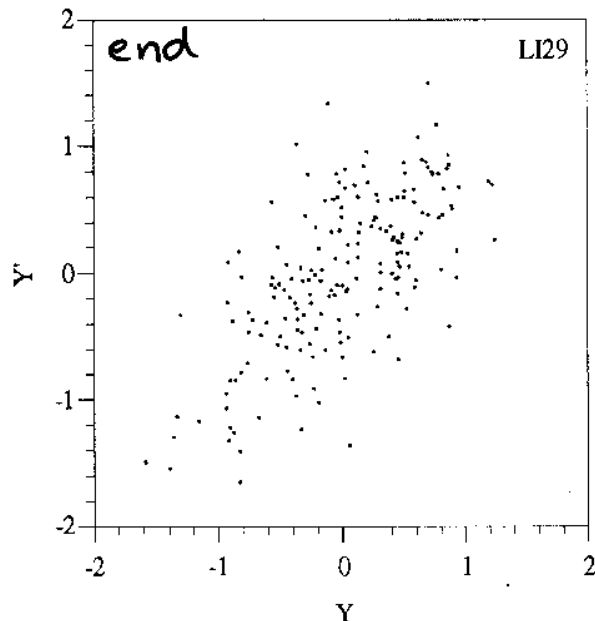
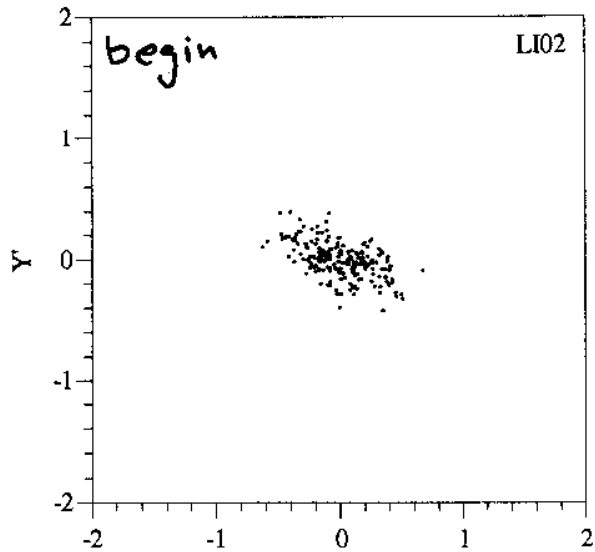

SLC example:
 Sequence of pulses

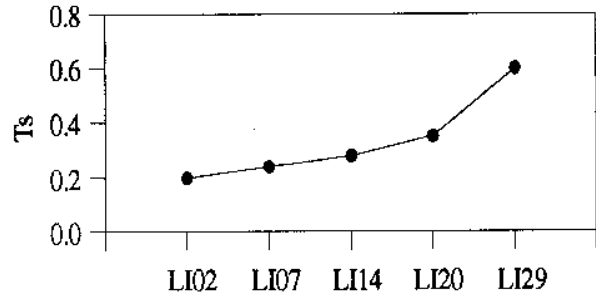

growth

units of INCOMING

Measured trajectories

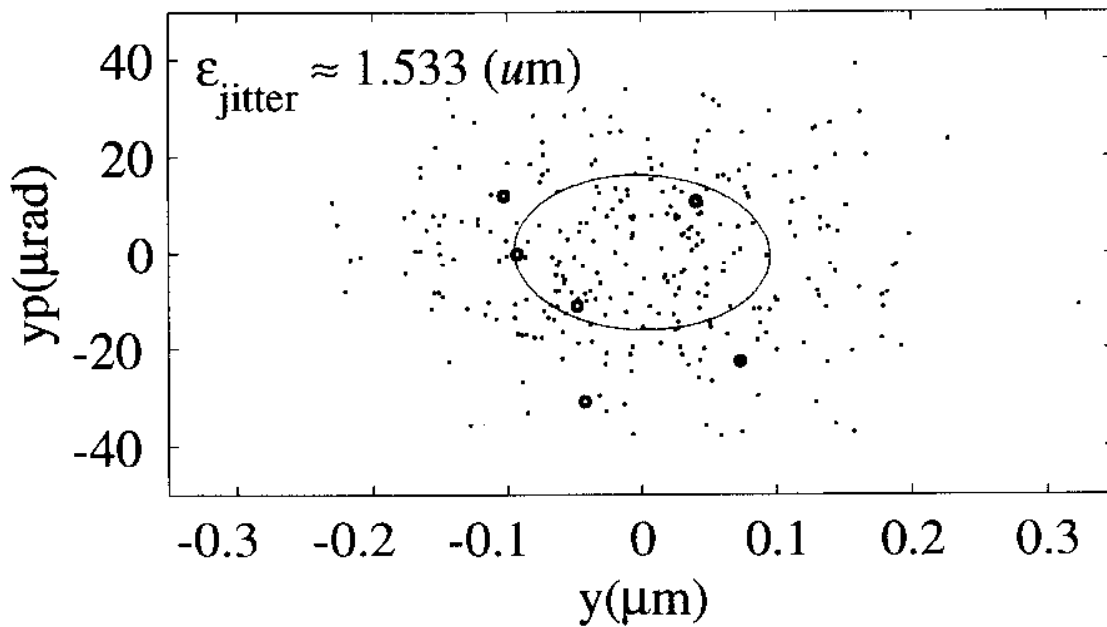
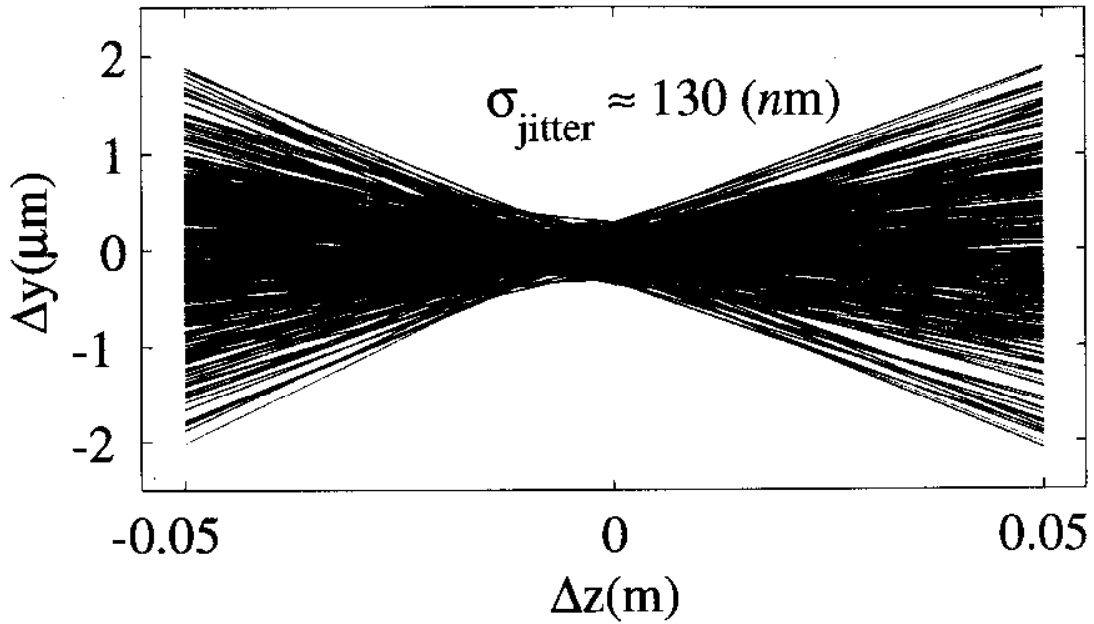

Jitter emittance

3' C band
uwave BPM's
monolithic

FFTB sample
(secondary IP)

Feedback

Look and adjust; low bandwidth

Tested throughout SLC and at many light sources

New work:

Optimization feedback

Luminosity winner

Replaces older procedure based parabola optimization

Inter-connection of many loops throughout the linac

non-linear system due to short range wakes

NLC Feedback Diagram

500 GeV c.m., 120 Hz, 95 Bunches, 2.8 ns Spacing

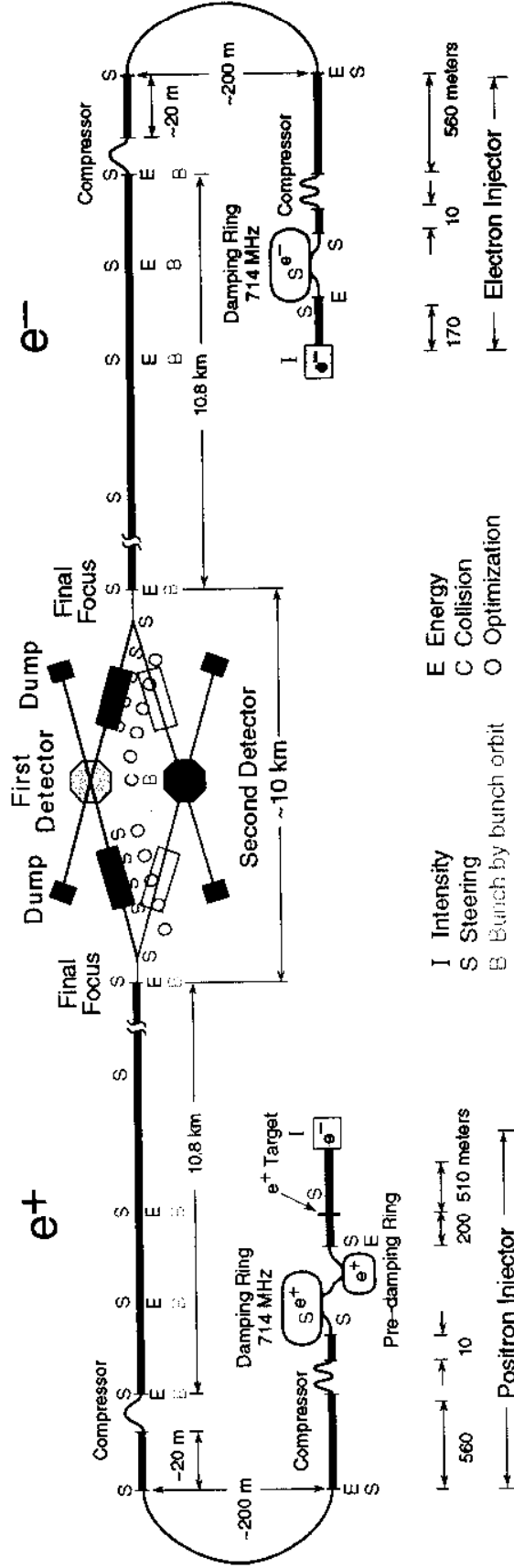

LUMINOSITY OPTIMIZATION

OLD:

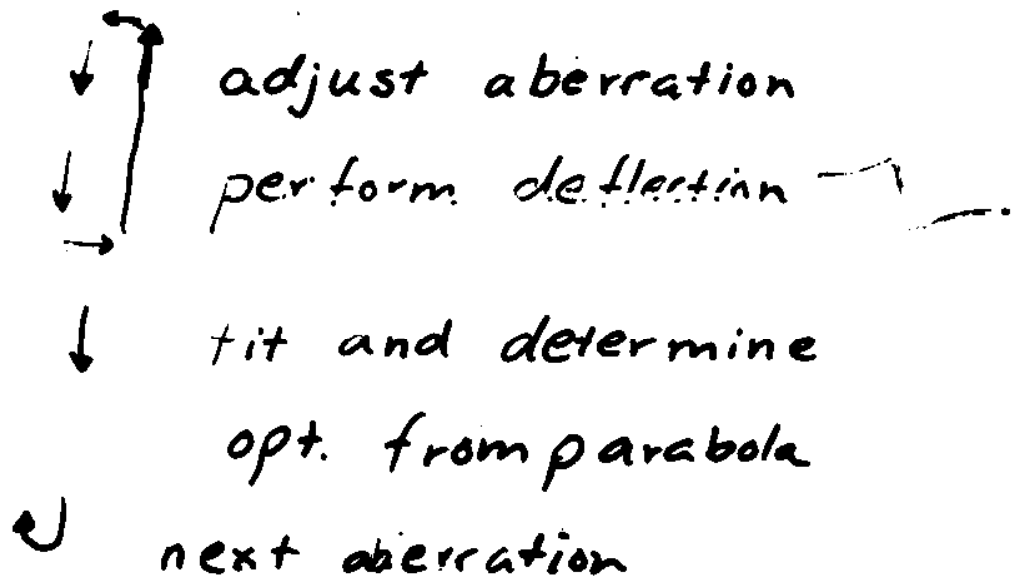

Precision? Stability? Errors?

NEW:

(Synchronous detection)

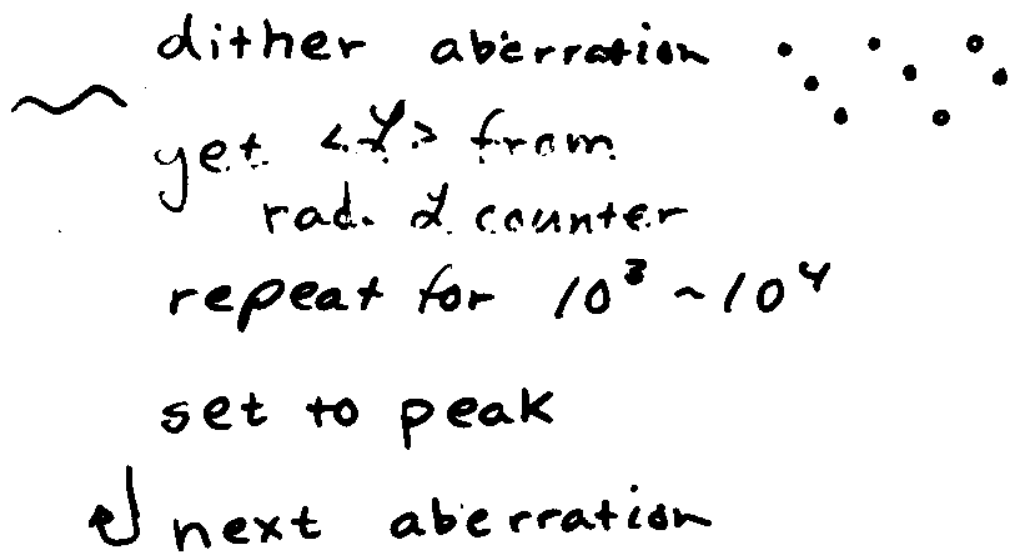

P. Emma

IT TUNING PRECISION

SLC measured

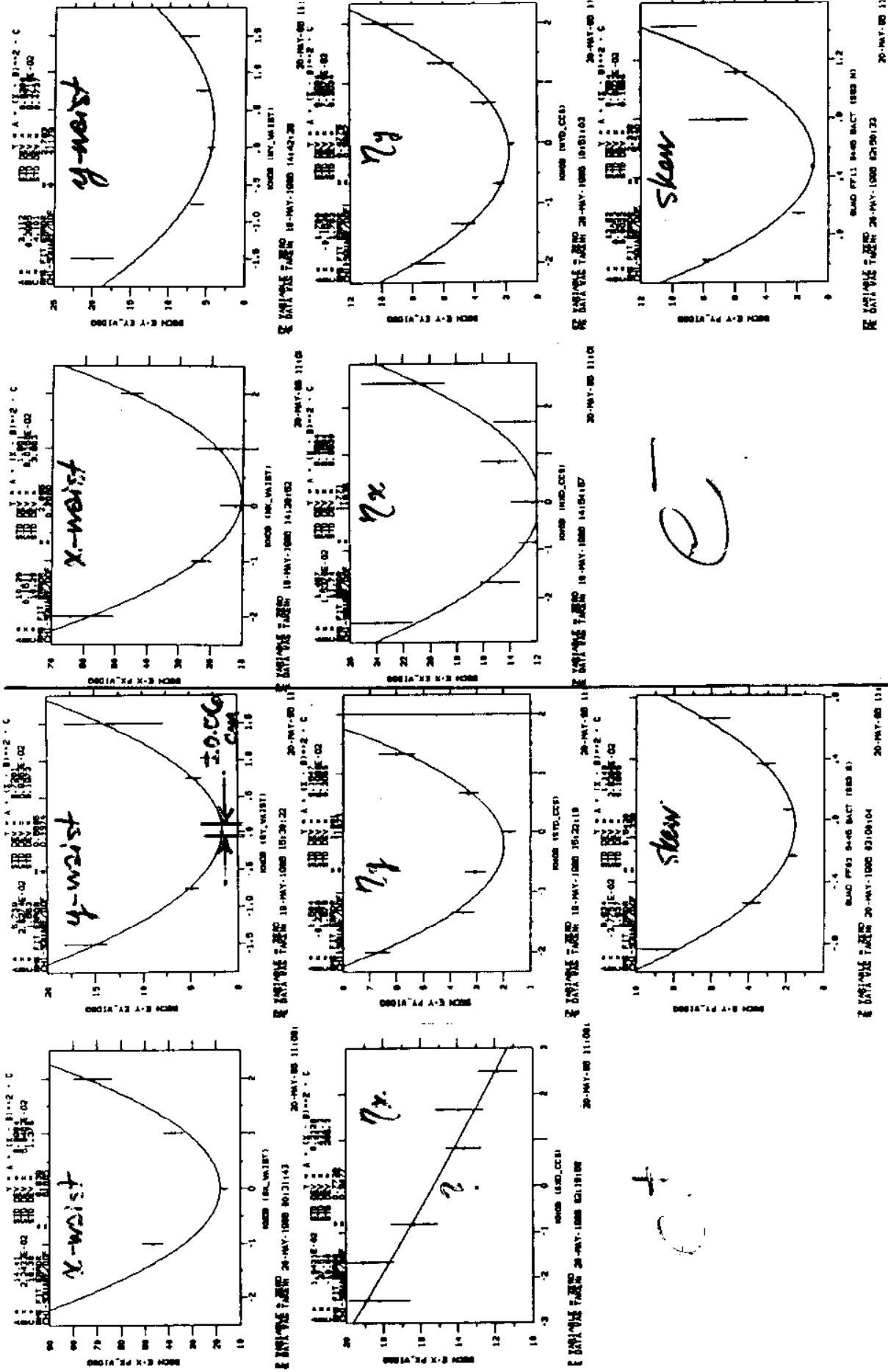

SLC LUMINOSITY FEEDBACK

DITHER - OPTIMIZATION

Nom. →

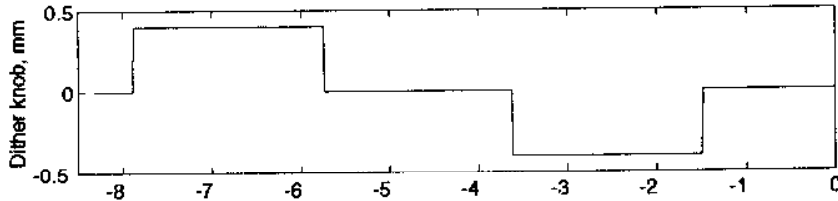

CONTROL

$e^+e^- \rightarrow \gamma e^+e^-$

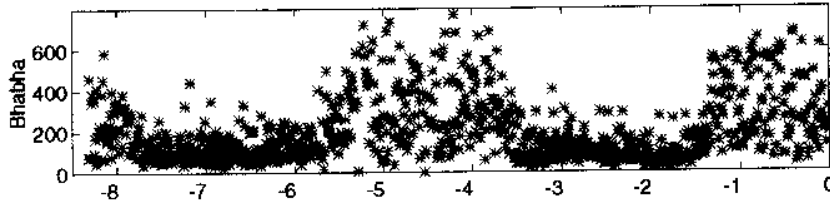

SENSOR #1

Beamstrahlung

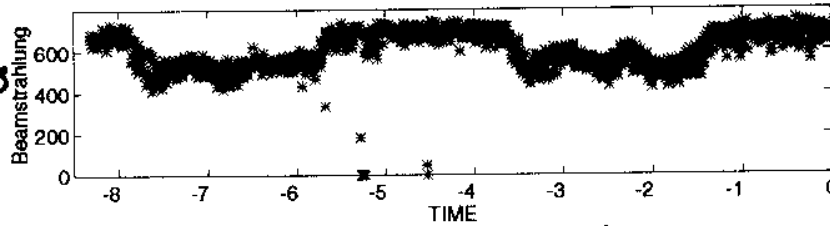

SENSOR #2

(s)

MEASUREMENT
COMPARISON

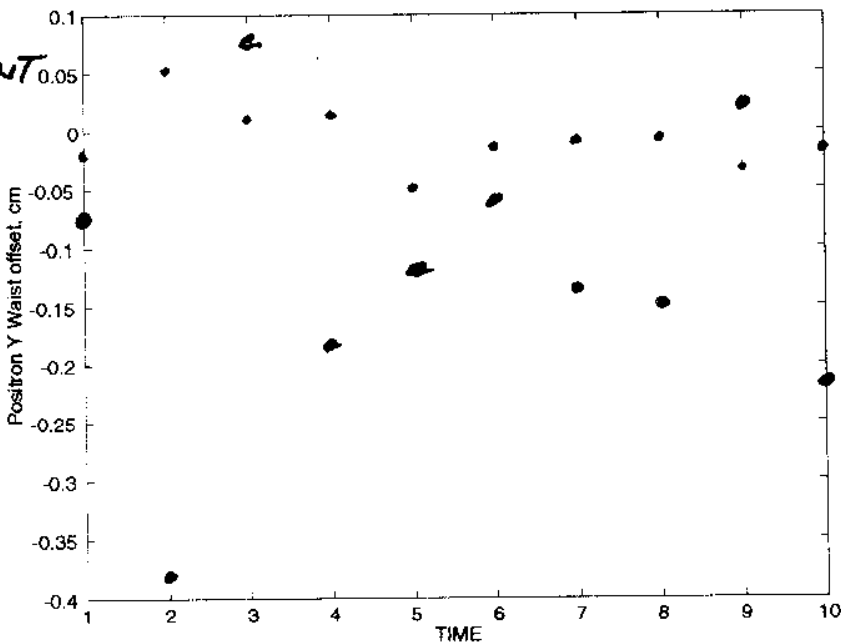

'SCAN'

'DITHER'

acq #

Luminosity Optimization and Measurement

<u>Tool</u>	<u>SLC</u>	<u>NLC</u>	<u>JLC</u>	<u>TESLA</u>
Deflection scans (BPMs)	yes	yes	yes	yes (horizontal only!)
Beamstrahlung	yes	no	no	no
Radiative Bhabhas	no	yes	yes	yes
Pairs	no	yes	yes	yes
Laserwire (horizontal)	no	no		yes
Laser interferometer (vertical)	no	no	yes	yes

Beamstrahlung
+
Rad. &
Counter
Schematic

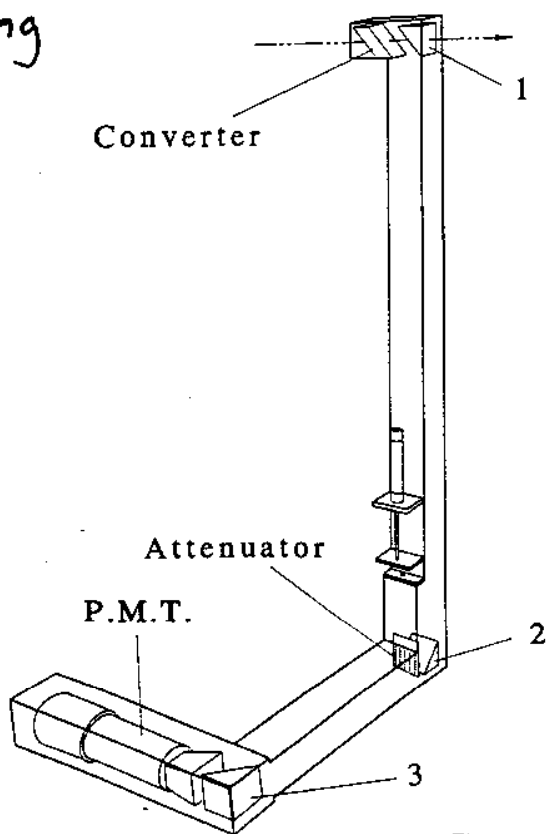

Beam
Elevation

SHIELDED
'PERISCOPE'

Fig. 4

Vibrations at SLC and FFTB?

SLC

geophone measurement of SLD triplets
gave 30-40nm rms vibrations for
 $f > 1\text{Hz}$

FFTB

40nm jitter contribution to 70nm σ_y
consistent with:
35nm contribution from geophone + 15nm beam jitter

IR Vibration Issues

-> want to collide beams with dimensions of 300nm x 5nm
=> require differential (vertical) motion of opposing quads
to be $\lesssim 1\text{nm}$

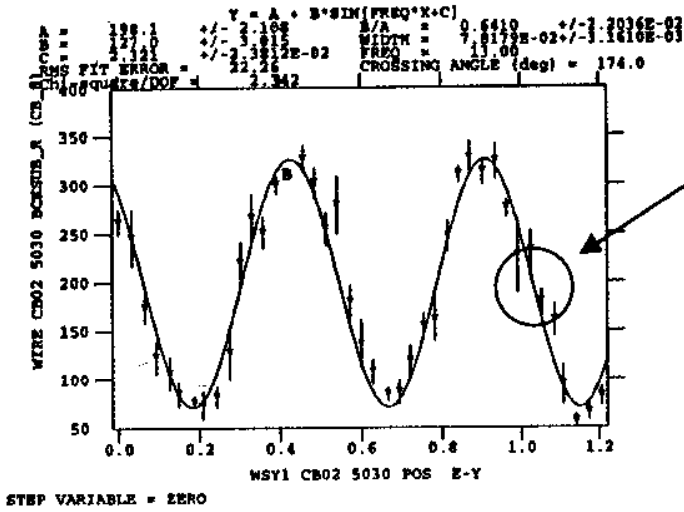

Inflection point

Beam jitter at the IP can be measured by placing the beam at an inflection point on the KEK BSM fringe pattern.

Each point is for 20 laser on pulses or 2 seconds of data. The error bars are a measurement of the beam's rms motion during the 2 second period.

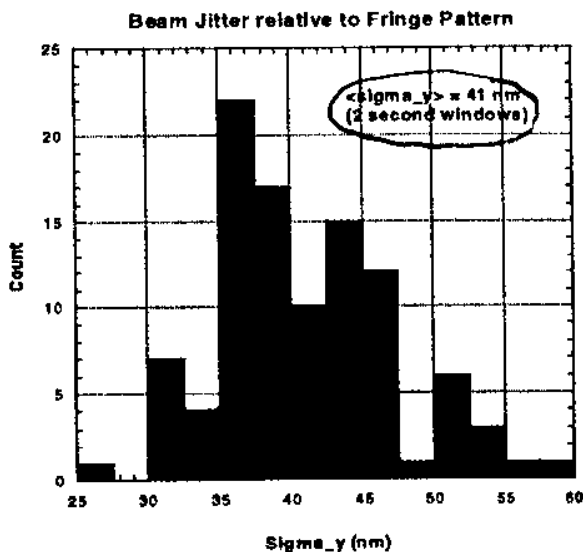
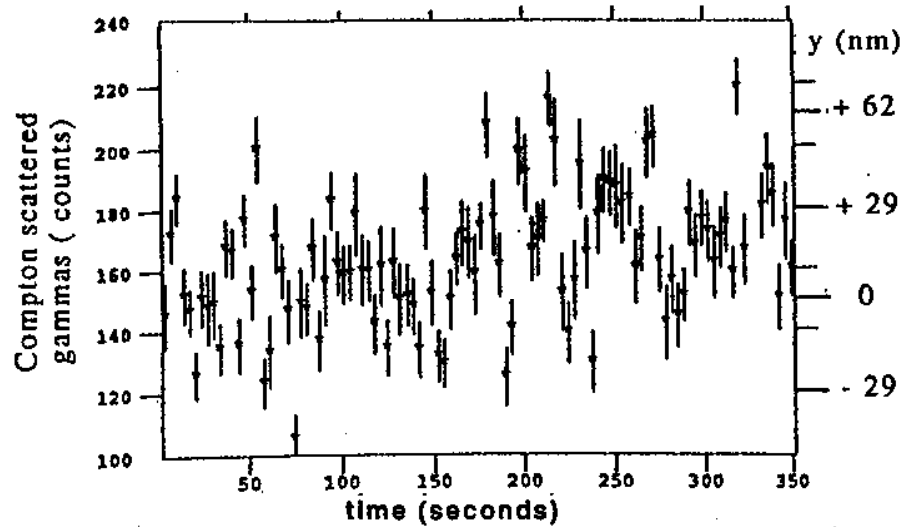

The histogram of the above error bars shows beam jitter relative to the fringe pattern of 41 nm. This is about a factor of 2 larger than what is expected for the 30% beam jitter to beam sigma ratio.

Fringe monitor anchored to end of FD table

Vibration sources:

- i) ground motion
- ii) cultural: pumps, fluid flows etc.
- iii) amplification of i) and ii) by mechanical structure

Ground Motion

- i) $f < 1\text{Hz}$ - approximately 200nm amplitude motion;
mostly microseismic peak
- correlated motion over large distances
- ii) $f > 1\text{Hz}$ - approx. 1 nm amplitude motion
- poor correlation at 10 meter separation

Cultural Vibrations

- can be much larger (1-2 orders of magnitude) than ground vibrations

- ┌ - frequency range approx. 1 - 100Hz
- > expect 10-50 nm ($f > 1\text{ Hz}$) uncorrelated motion at 10 meter separation for FF quads

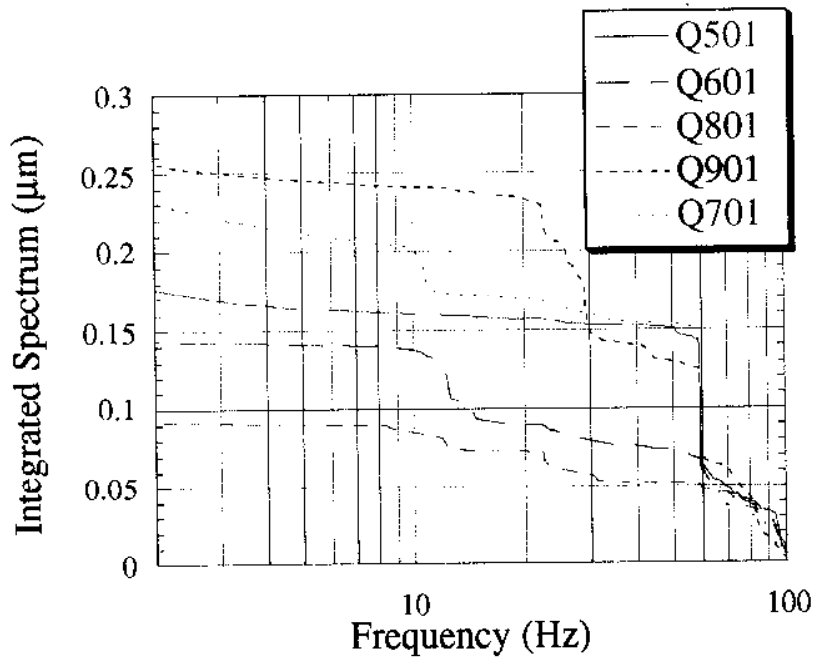
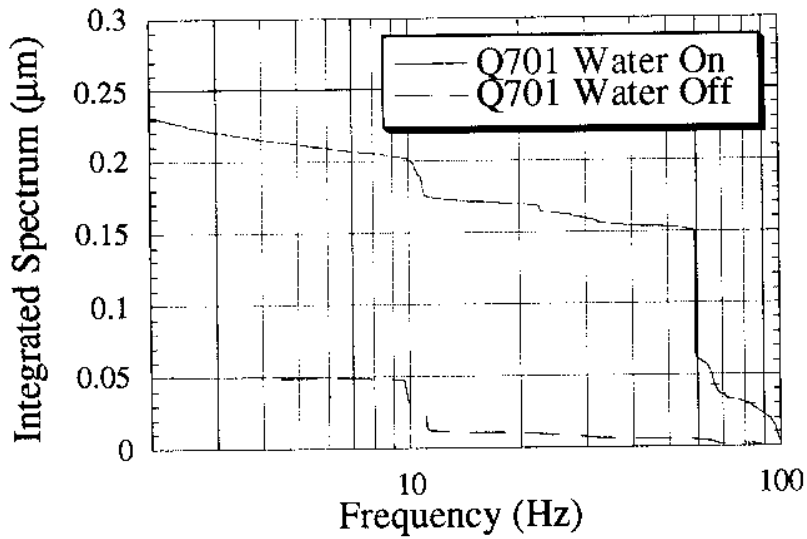
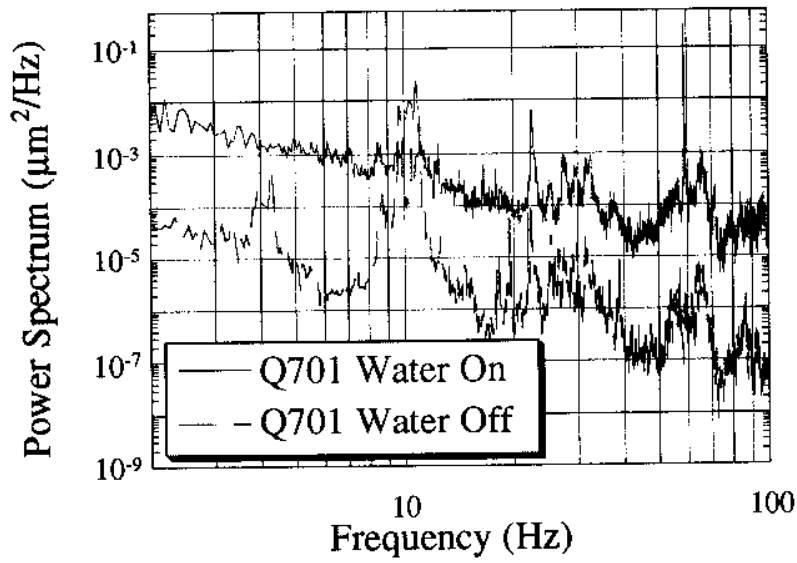

Motion Sensor for Active Vibration Damper

capable of sensing sub-nanometer motions.
Several technologies are available:

Electron Beam: The Electron beam must be used for low frequency feedback.

- 1.Measures exactly the quantity of interest (direct measurement)
- 2.Provides an exact measure at DC
- 3.Does not require additional equipment.

but:

- 1.Readout frequency is 120Hz, limits feedback frequency to about 10Hz
- 2.Readout frequency lower at lower beam rate
- 3.Signal disappears when the beam is lost.

Laser Interferometer:

high accuracy measurements with sub-nanometer resolution.
can be arranged to measure the difference between the two IP quadrupoles.
DC to KiloHertz.

1. Good long term stability ($\sim 10\text{nm}$) in vacuum, unless the beam is interrupted
2. Well integrated commercial product

but:

1. Measures quad position relative to the detector hall floor (indirect measurement)
2. Requires an invasive optical path.
3. Air path must be very limited - less than a few cm
4. Optical equipment somewhat bulky

Inertial Sensors: Accelerometers and geophones.

Standard accelerometers do not have sufficient noise
geophones cannot operate in high magnetic
fields.

A capacitive inertial sensor could have sufficient
resolution.
few hertz to kilohertz.

- 1.Compact sensor system
- 2.Measures relative to the "fixed stars" (essentially direct for high frequencies)

but:

- 1.Does not provide a DC measurement
- 2.Has low frequency resonance which may confuse measurement

Final Focus Stabilization Decision Tree

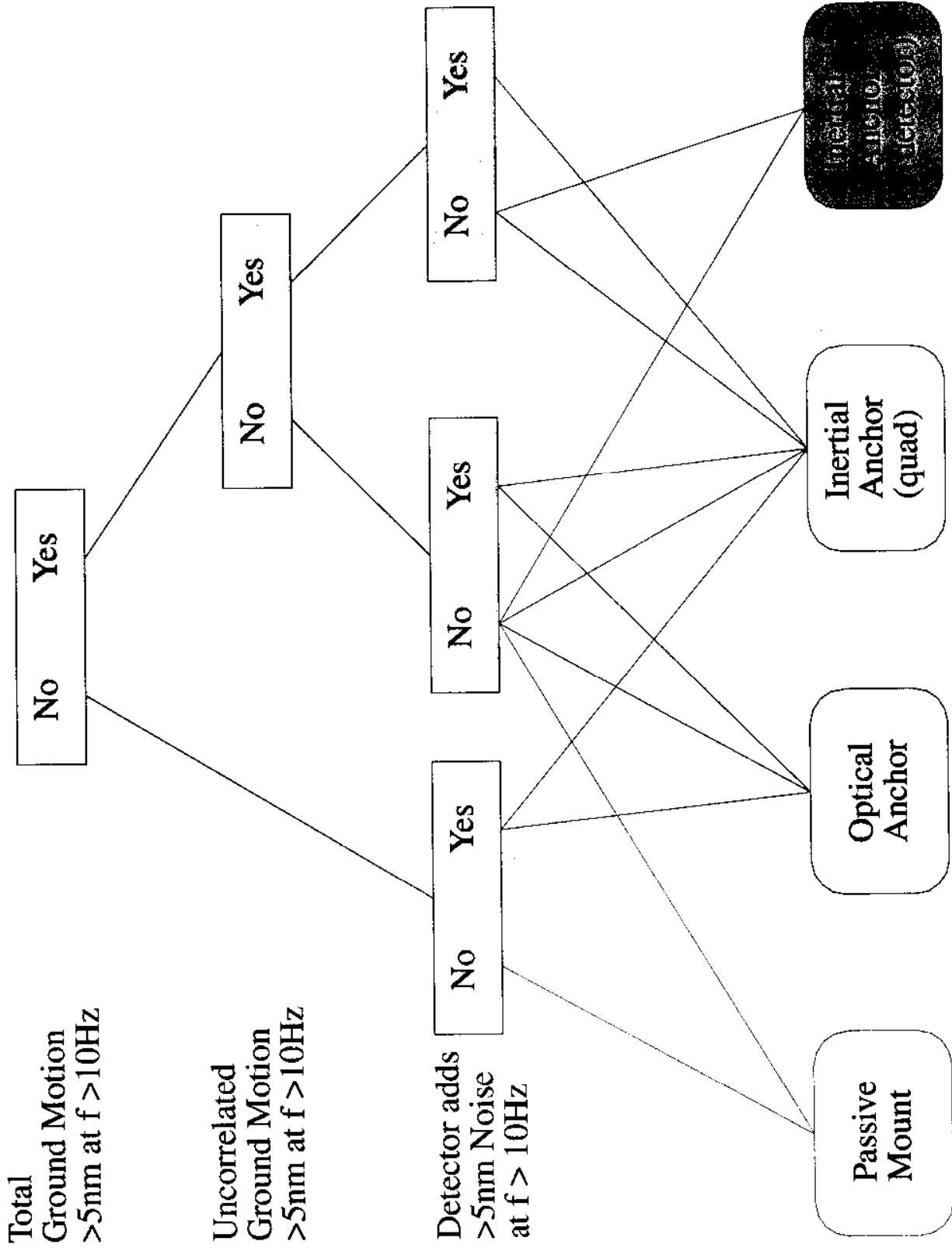

VERTICAL TRANSMISSIBILITY

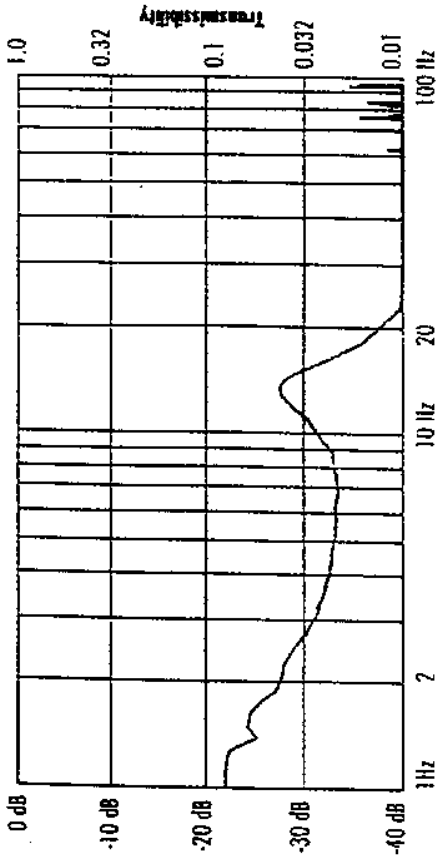

HORIZONTAL TRANSMISSIBILITY

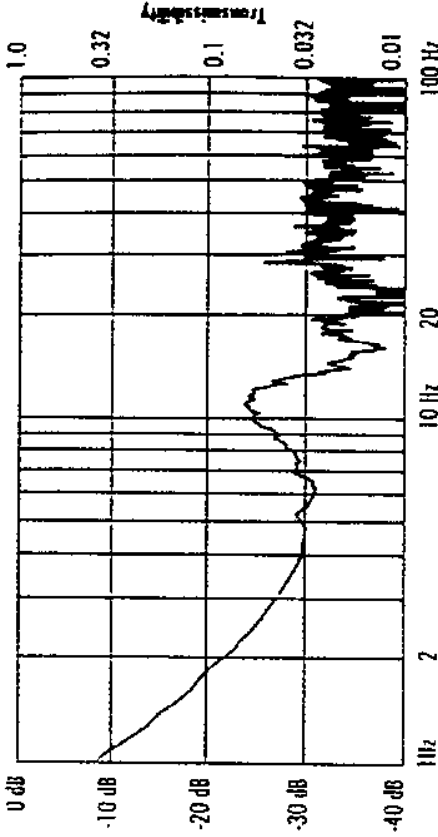

Performance Specifications:

Active degrees of freedom	6
Active bandwidth	0.3 to 250 Hz
Resonant frequency (active):	0.2 Hz
Transmissibility at resonance:	< 1.1
Isolation above 2.0 Hz:	> 90 %
Settling time after a 10 lb. (4.5 kg) step input: (10:1 reduction)	0.3 second
Internal noise:	< 0.1 nm rms
Operating load range per isolator: (different passive mounts required)	400 - 3500 lb. (182 - 1590 kg)
Isolator overload safety factor:	> 2:1
Number of isolators:	3 or 4
Maximum displacement:	950 μ inches (24 μ m)
Stiffness (1000 lbs./454 kg mass): (typical middle capacity isolator)	40,000 lbs./in (73 x 10 ³ N/m)
Magnetic field emitted	< 0.02 micro-gauss broadband rms

TECHNICAL

Manufacturing Corporation

VIBRATION
SUPPRESSION
SUPPORT

Detector Stabilization Scheme

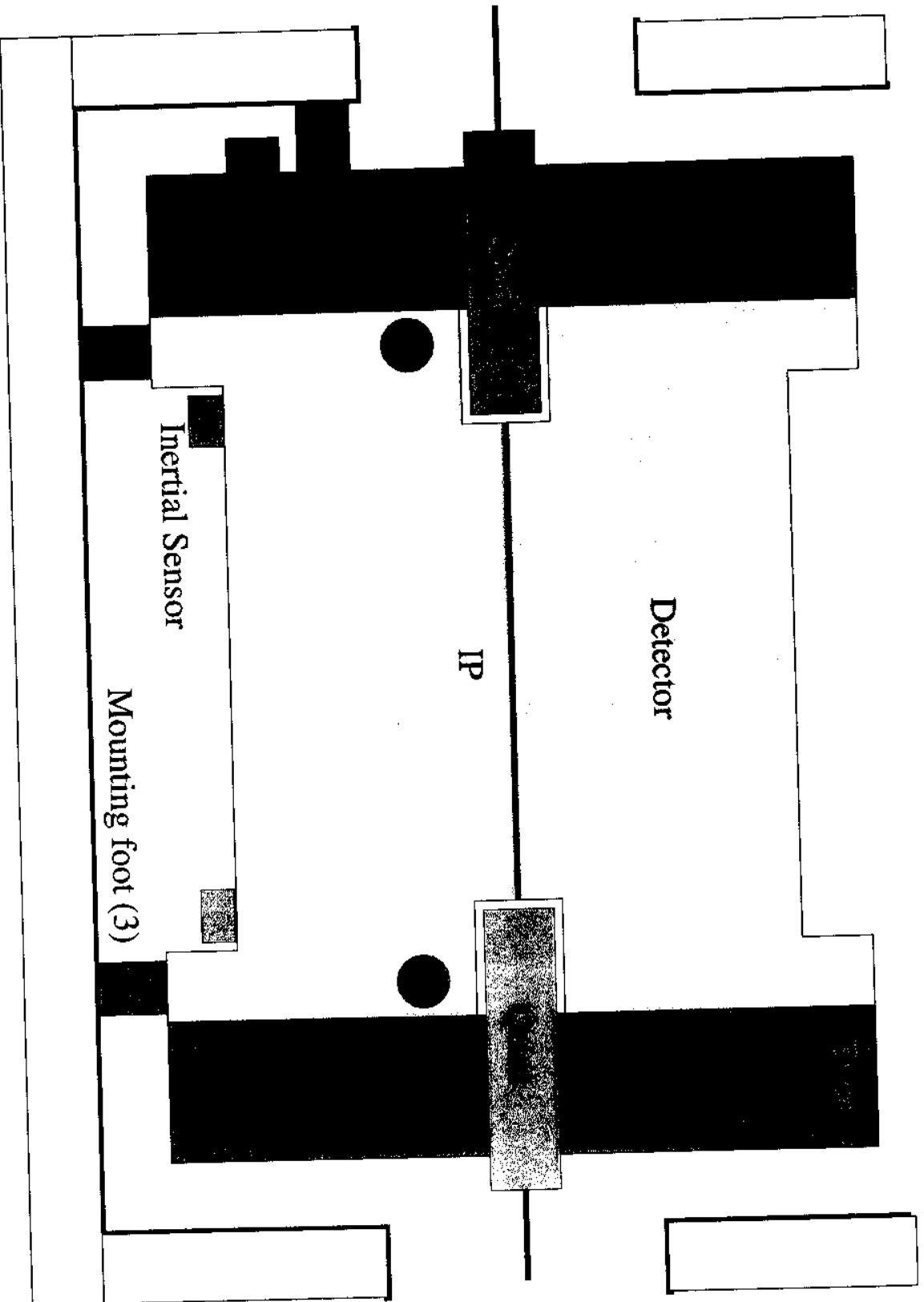

Generic 6 point Support and Read Back

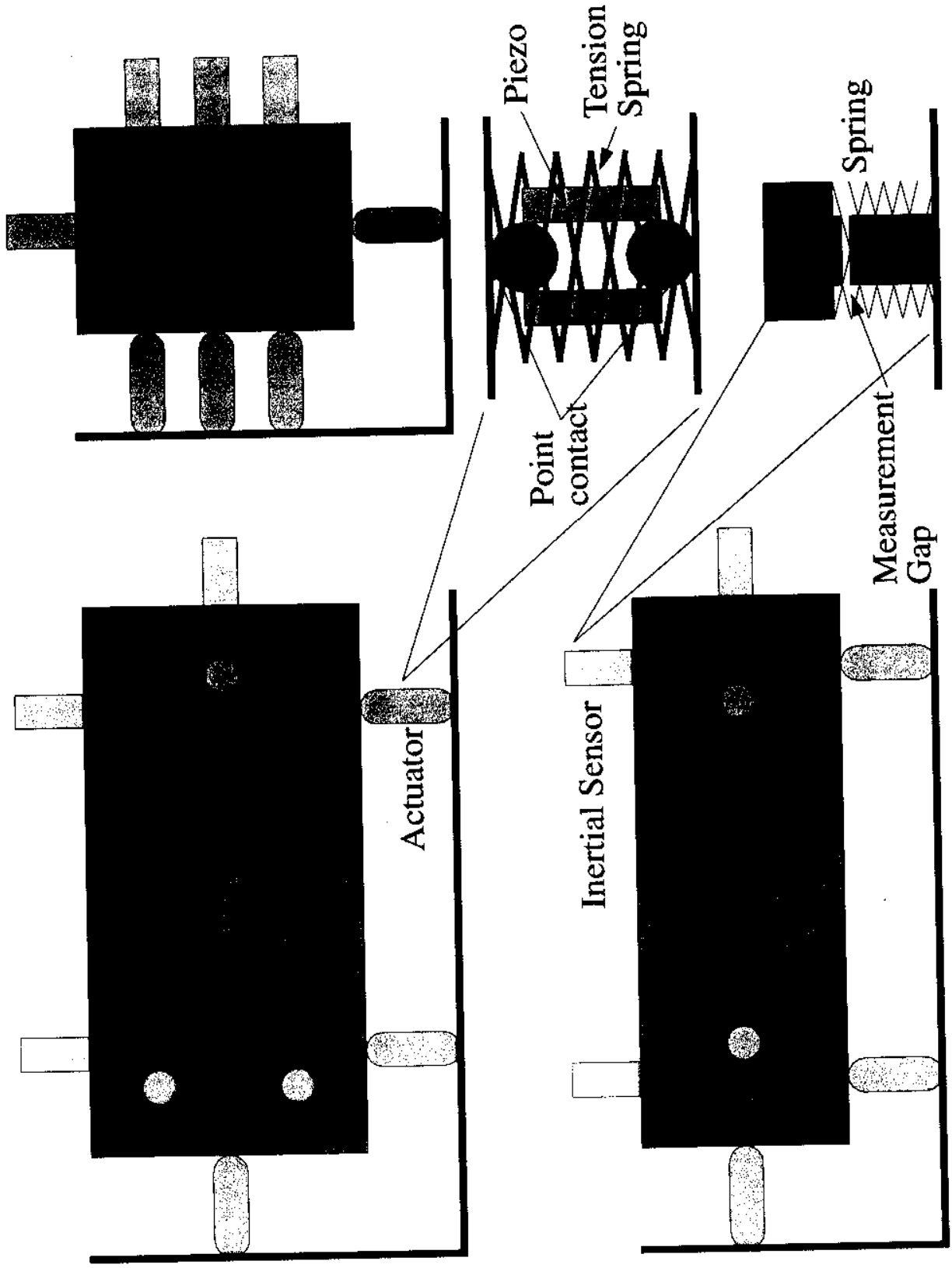

SLC e^+ TARGET - $\frac{W \cdot Re}{6 \lambda_r}$ - semi-sintered material

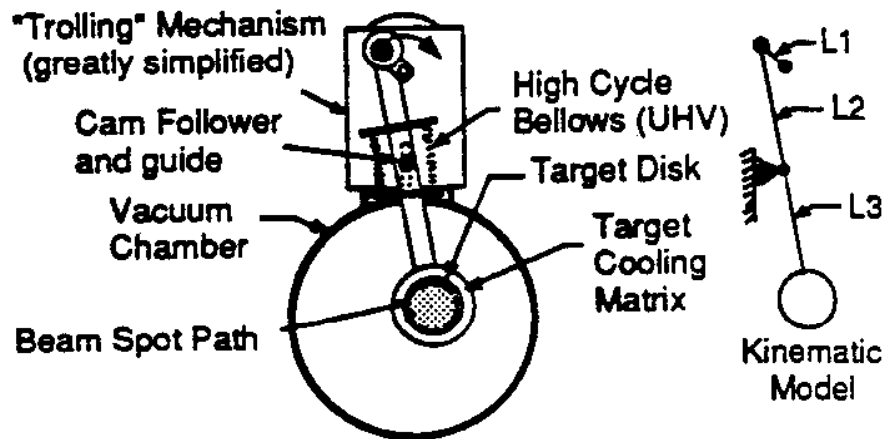

Looking Downbeam

3-91

6894A1

Figure 1. "Trolling" target mechanism.

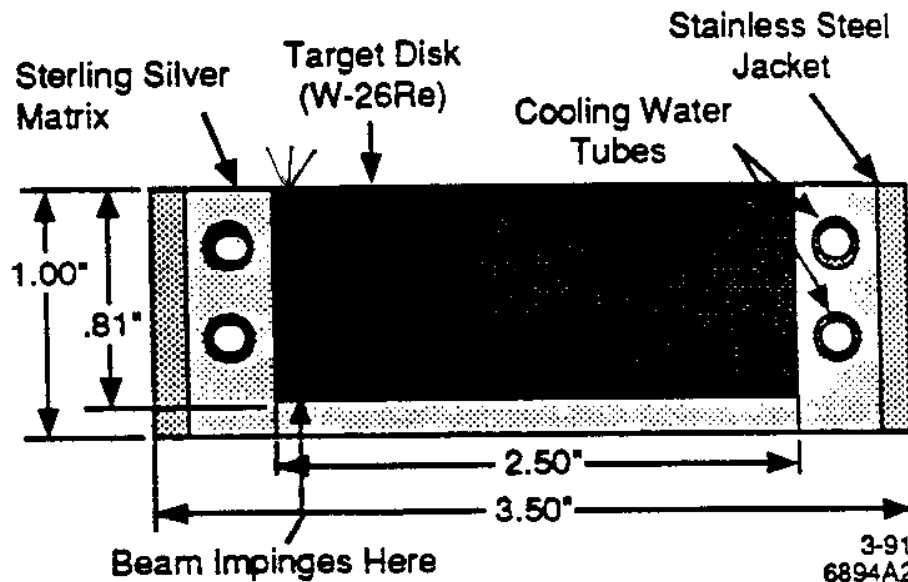

3-91

6894A2

TARGET FAILED after 6 yrs; 5×10^9 pulses, 20 million cycles

2 problems. 1) low vacuum leak

spallation

TORO PT01 376 DATA

Beam on target 1993 → 1998

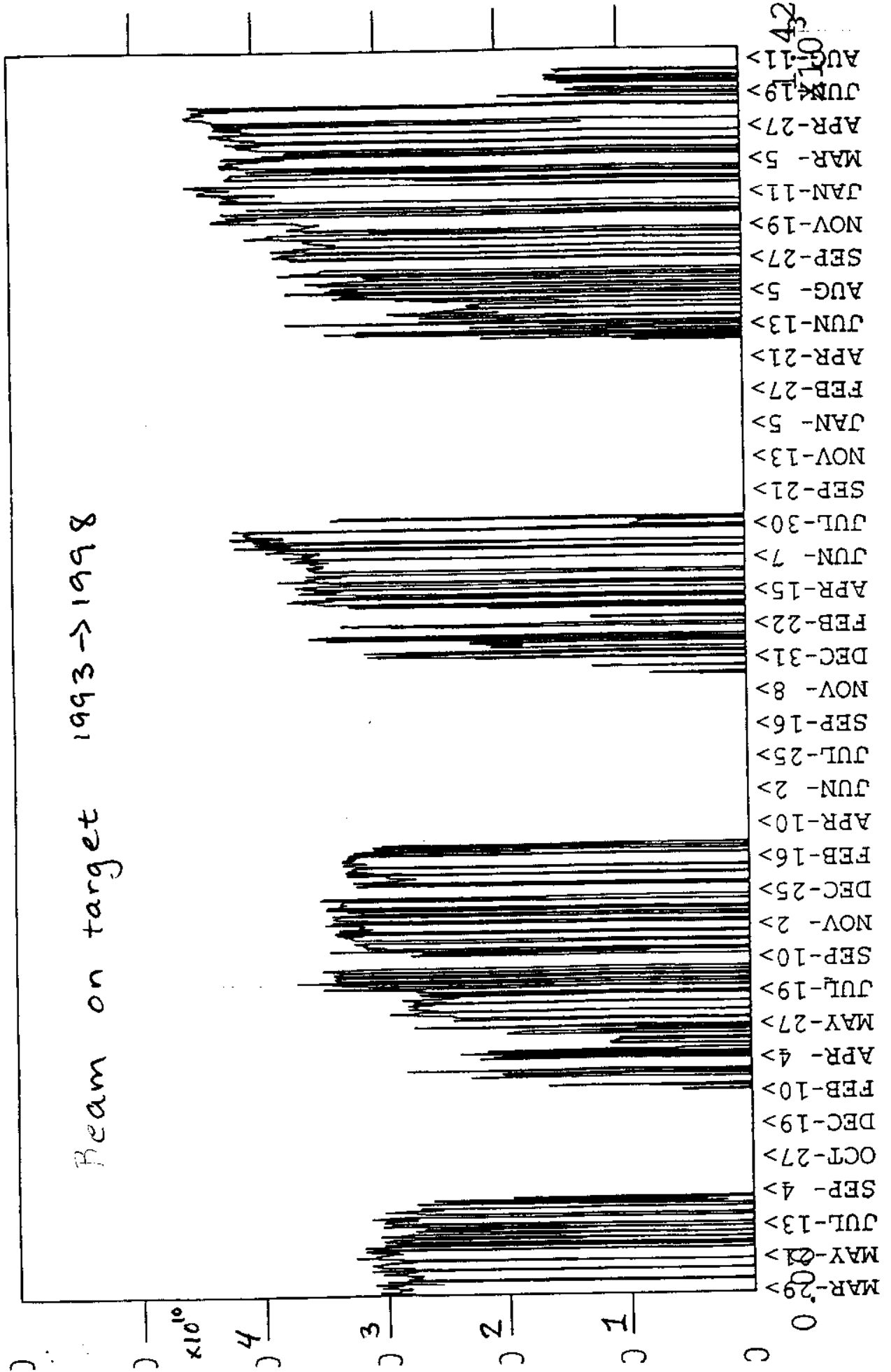



STANFORD UNIVERSITY (SLUC-PEL)

15kV . 080kx 125µ 011

FILE: 001206
DATE: 11/02/98 TIME: 16:59
Positron target debris, particle #5



STANFORD UNIVERSITY (SLAC-PEL)

15kV · 1.00kx · 10.0μ · 012

FILE: 001287
DATE: 11/02/98 TIME: 17:04
Positron target debris, particle #5

Damping Rings –

Similar in many ways to 3rd generation light sources,
B-factories
Ring performance pivotal

Very small beams – few μm

Modern optics – ‘TME’
Minimum momentum compaction;
Small β_x in bends

High I

0.8 Amp – 2 to 3×10^{12}

Tight vacuum tolerance

< 1 nTorr average

Injection/extraction

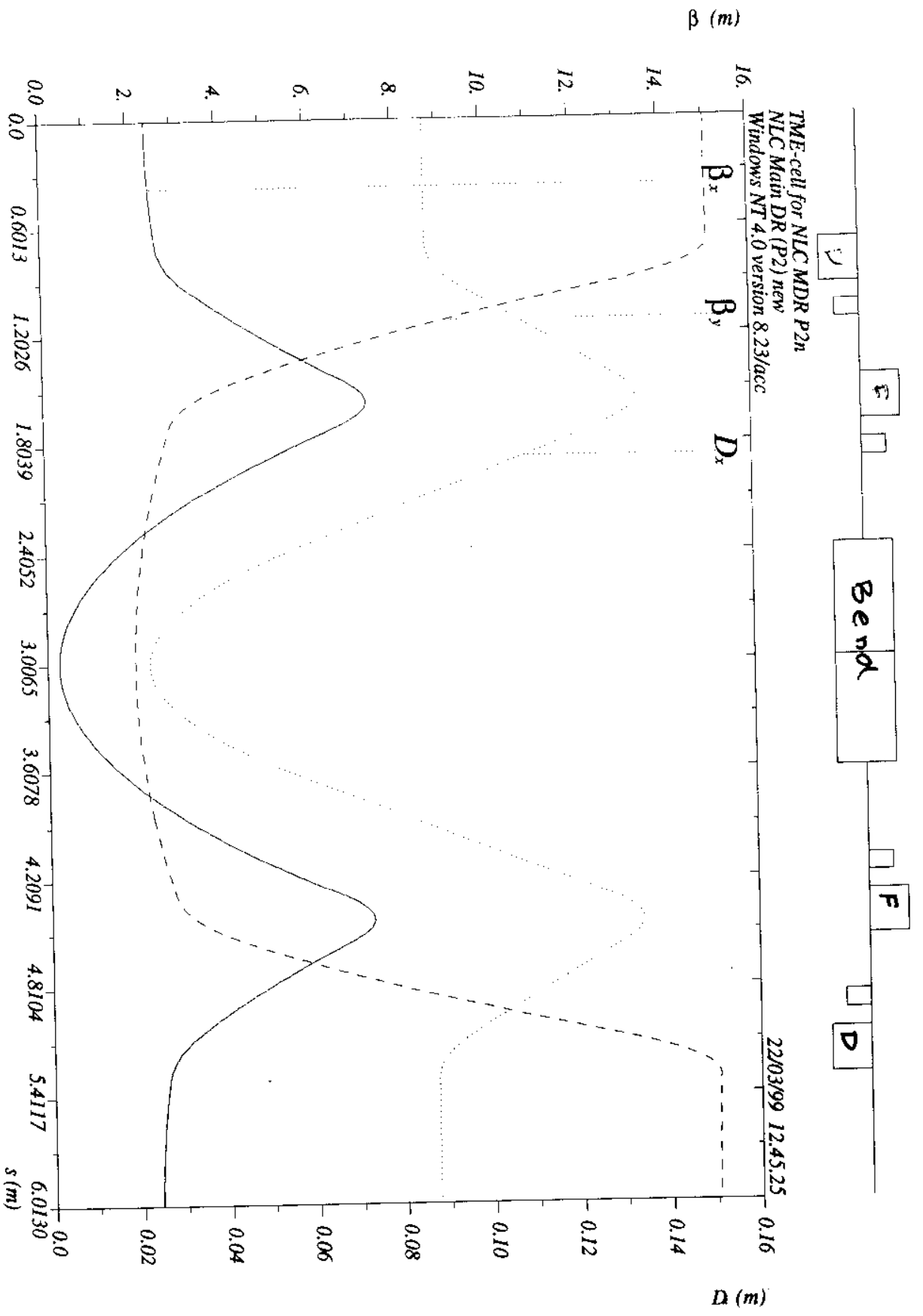

$S\beta/p_{oc} = 0.$

Table name = TWISS

NLC POSITRON INJECTOR SYSTEM

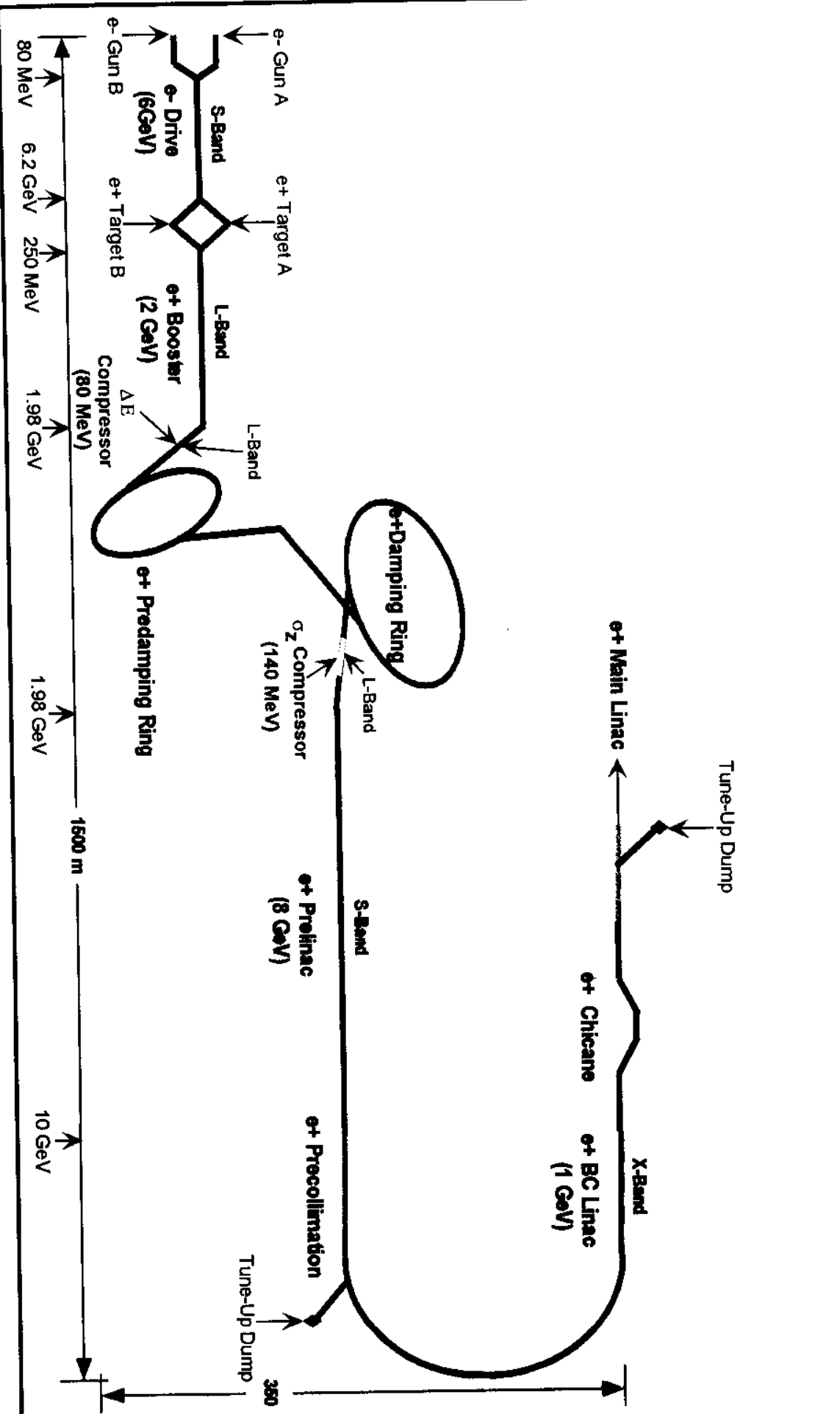

Damping Ring Layout

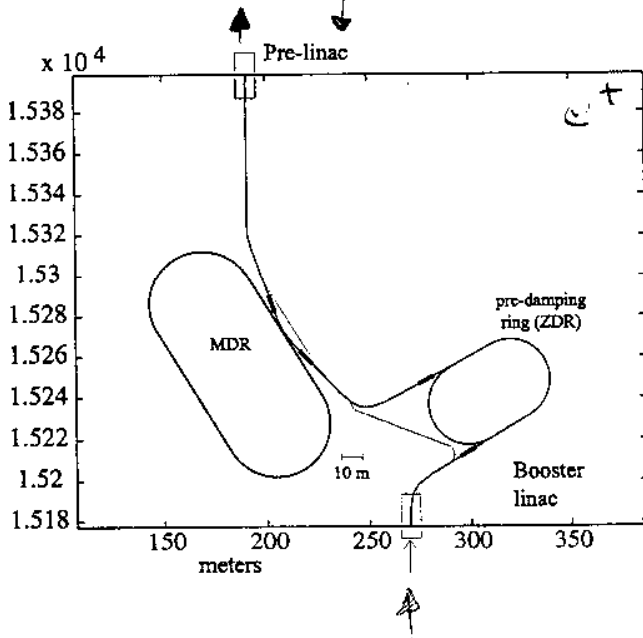
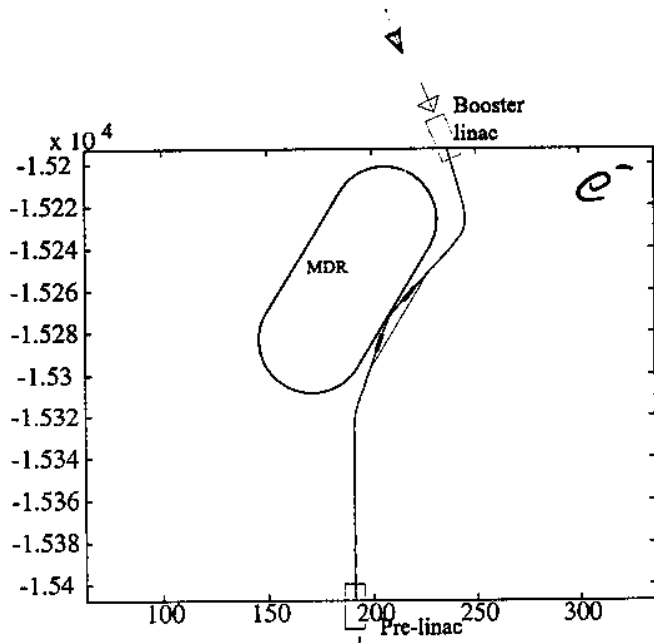

BUNCH
LENGTH
COMPRESSION

$\langle E \rangle = 1.9800 \text{ GeV}, N_e = 0.750 \times 10^{10} \text{ ppb}$

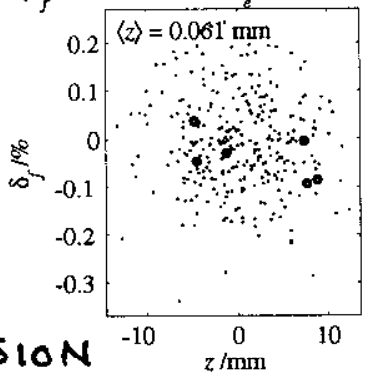

$\langle E \rangle = 8.0000 \text{ GeV}, N_e = 0.750 \times 10^{10} \text{ ppb}$

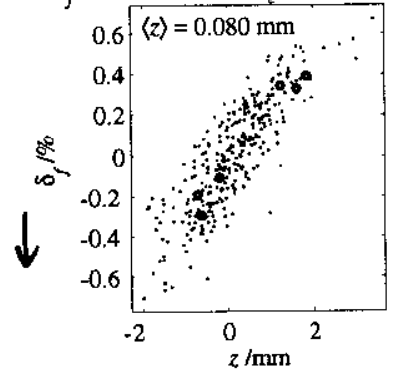

$\langle E \rangle = 1.9803 \text{ GeV}, N_e = 0.750 \times 10^{10} \text{ ppb}$

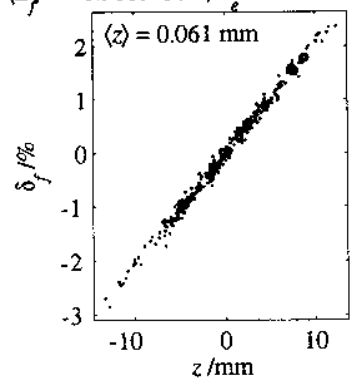

$\langle E \rangle = 7.9155 \text{ GeV}, N_e = 0.750 \times 10^{10} \text{ ppb}$

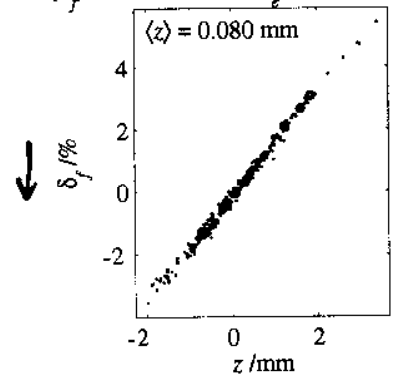

$\langle E \rangle = 1.9803 \text{ GeV}, N_e = 0.750 \times 10^{10} \text{ ppb}$

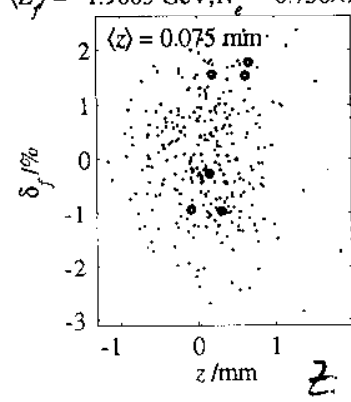

$z \rightarrow$

$\langle E \rangle = 7.9155 \text{ GeV}, N_e = 0.740 \times 10^{10} \text{ ppb}$

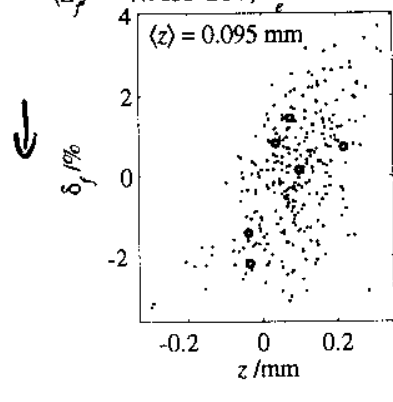

$\langle E \rangle = 8.0000 \text{ GeV}, N_e = 0.750 \times 10^{10} \text{ ppb}$

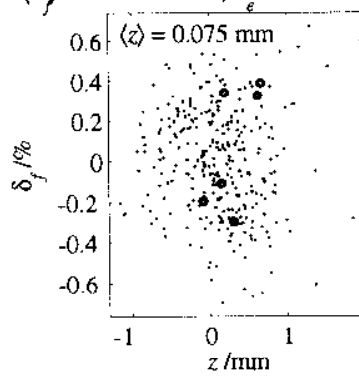

$\langle E \rangle = 500.0517 \text{ GeV}, N_e = 0.728 \times 10^{10} \text{ ppb}$

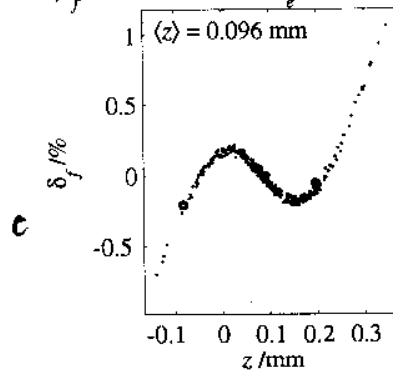

c

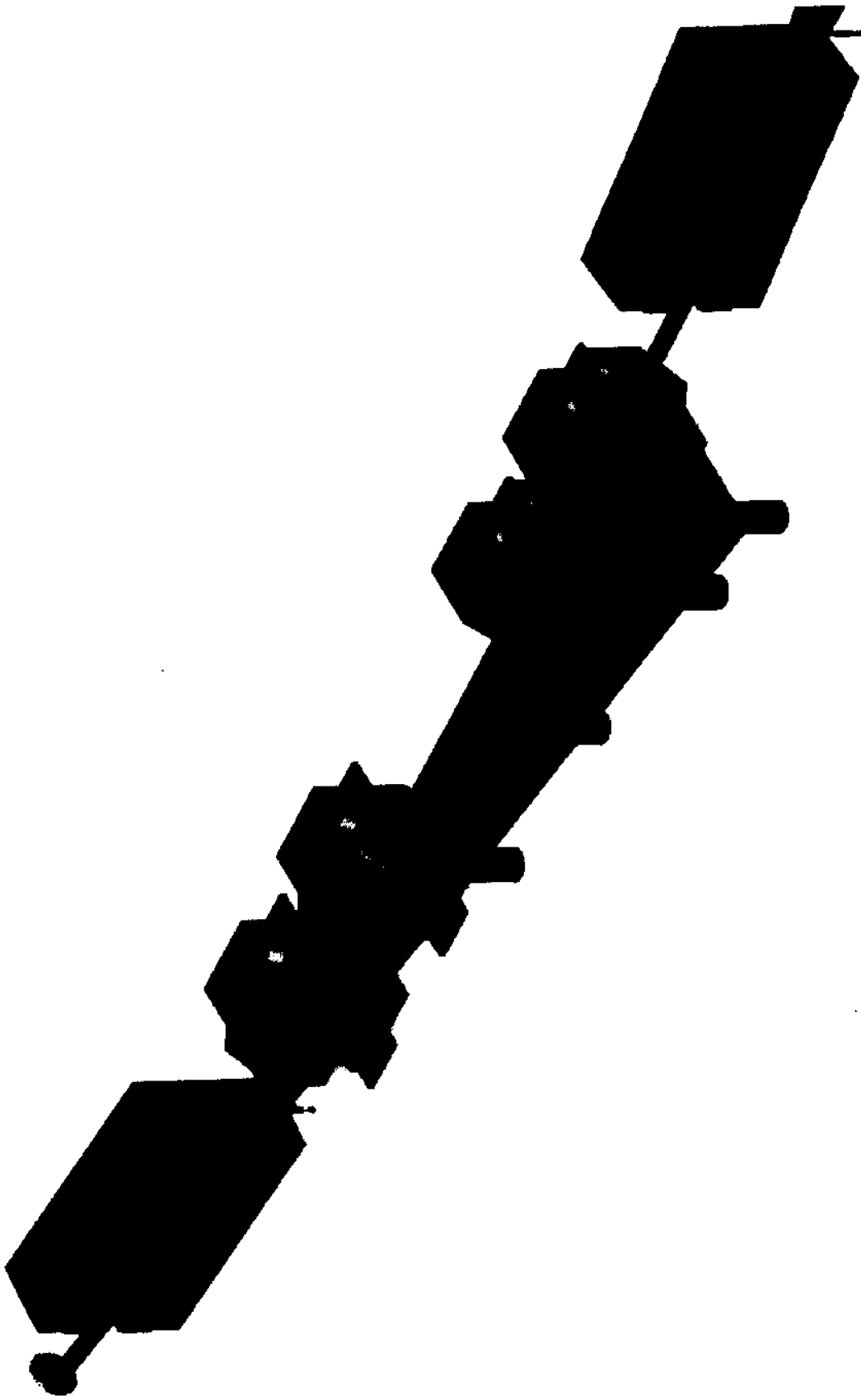

EXPERIENCE:

APS (Borland)– Feedback corrects for daily and seasonal circumference changes by adjusting RF. All high η BPMs averaged. Typical adjustments:

$\alpha = 2.28e-4$	daily	monthly	seasonal
df (Hz)	10	30	90
dI/I	2.8e-8	8.5e-8	2.5e-7
dE/E	0.012%	0.036%	.1%
dI (mm)	0.03	0.1	.28

APS is constructed at grade level surrounded by blocks in a large annular building. $l=1104m$.

ATF – Manual feedback to correct for seasonal effects.

$\alpha = 1.9e-3$	seasonal
df (Hz)	30KHz
dI/I	3.8e-5
dE/E	2%
dI (mm)	5

ATF is constructed on a slab at grade level in a large warehouse. $l=135m$. Large scale construction is underway outside of ATF.

Both ATF and APS are constructed in temperature controlled buildings.

MDR – suppose \rightarrow what does it take to move E one unit σ_E ?

$\alpha = 4.65e-4$	
df (Hz)	300 Hz
dI/I	4.2e-7
dE/E ($=\sigma_E$)	0.09%
dI (mm)	.12

What are the tolerances on extraction E?

PEP2 LER
 world's highest I
 e⁺ ring

HISTORY

LB60: DCCCT: INTCURR

SI

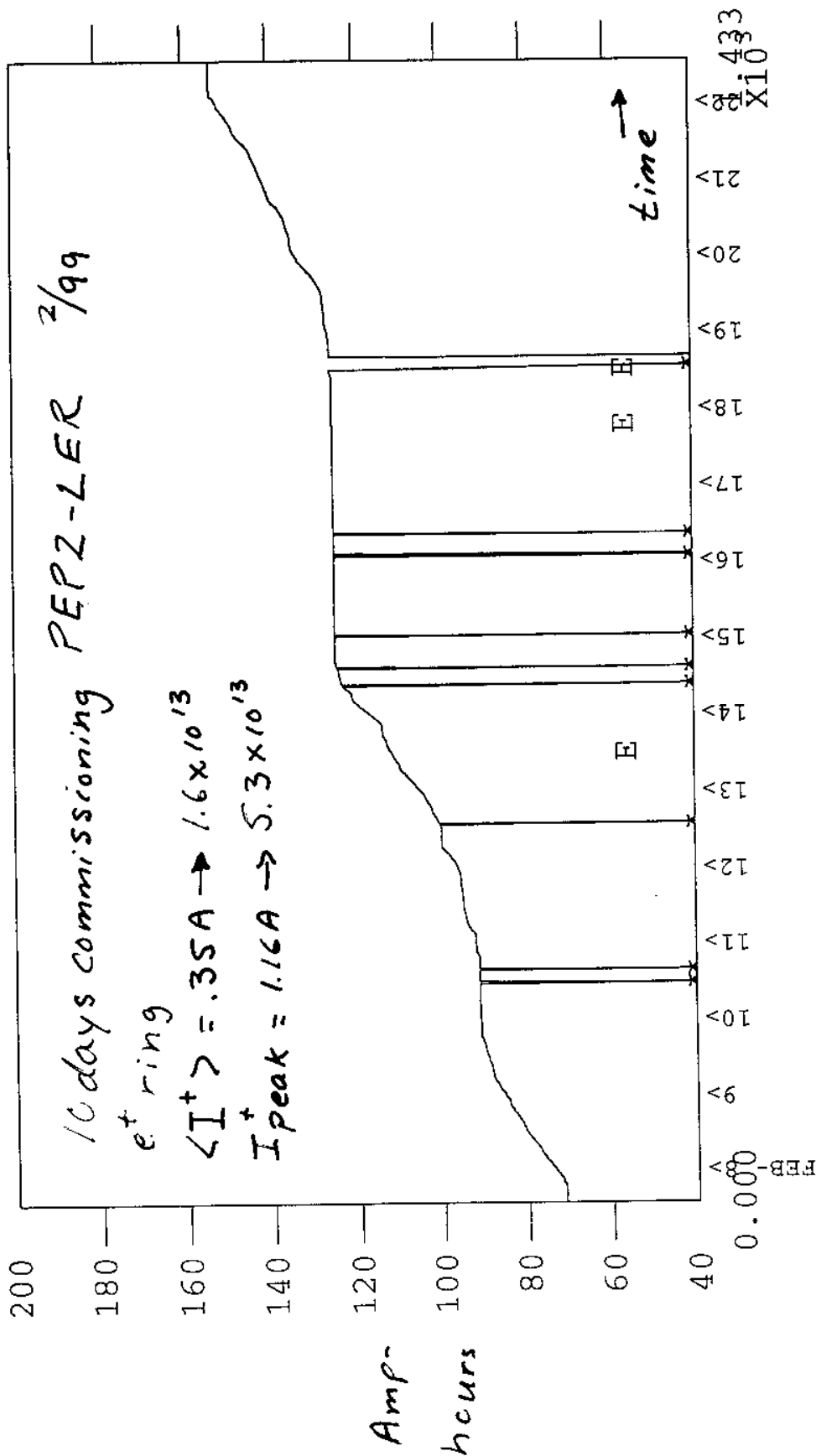

MIN: 0.0000
 MAX: 153.26
 MAX-MIN: 153.26
 20-MAR-99 14:09:07

INTERVAL: 180
 MEAN: 112.34
 SIGMA: 25.829
 LAST DATA POINT: 22-FEB-1999 14:07:11

BUNCH LENGTH INSTABILITY

- SLC DAMPING RING -

Instability pattern vs. beam current, $V_g=800\text{kV}$

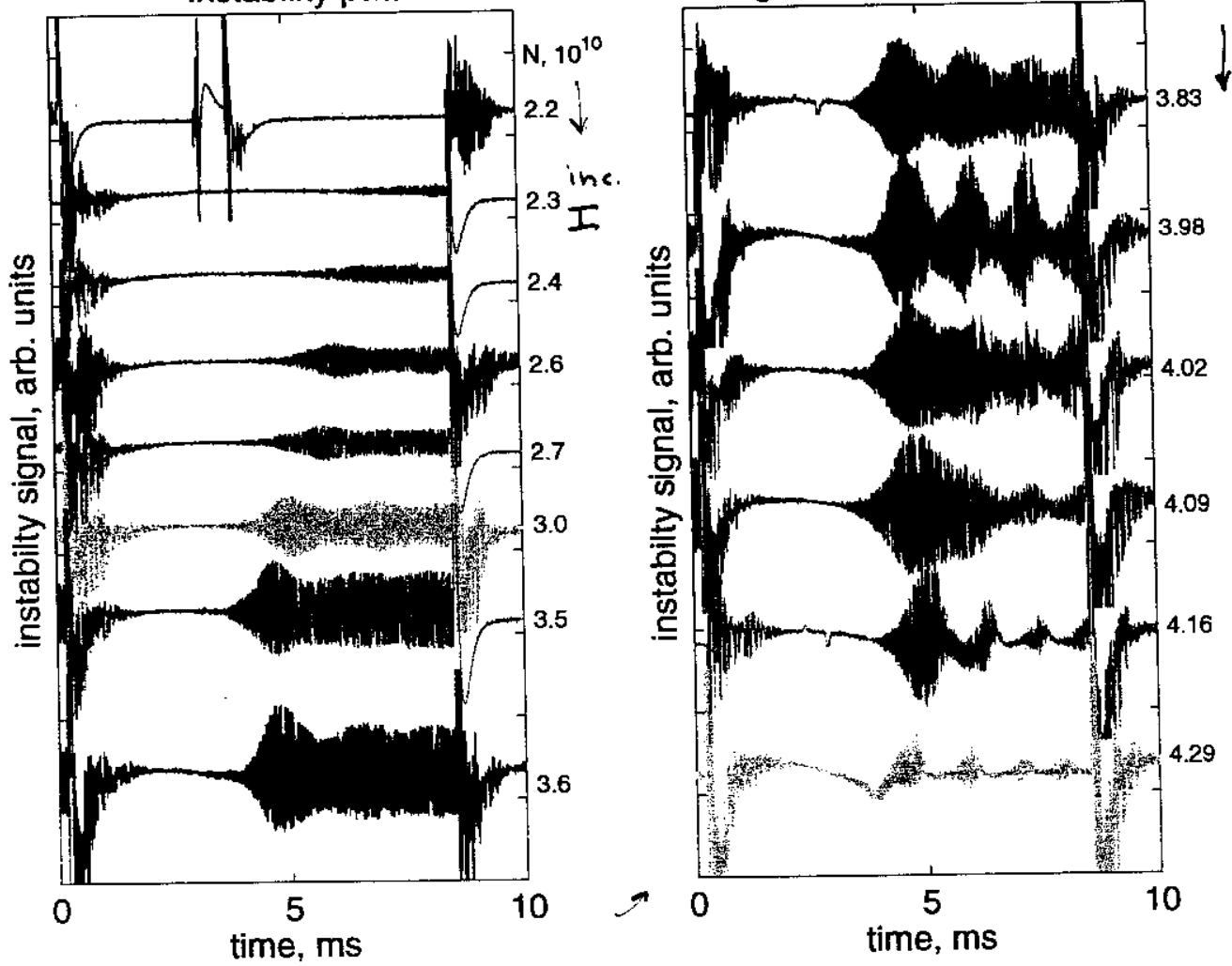

B. Podobedov and R. Siemann, Sept. 1997
Preliminary

Average Profiles for Different Instability Phases

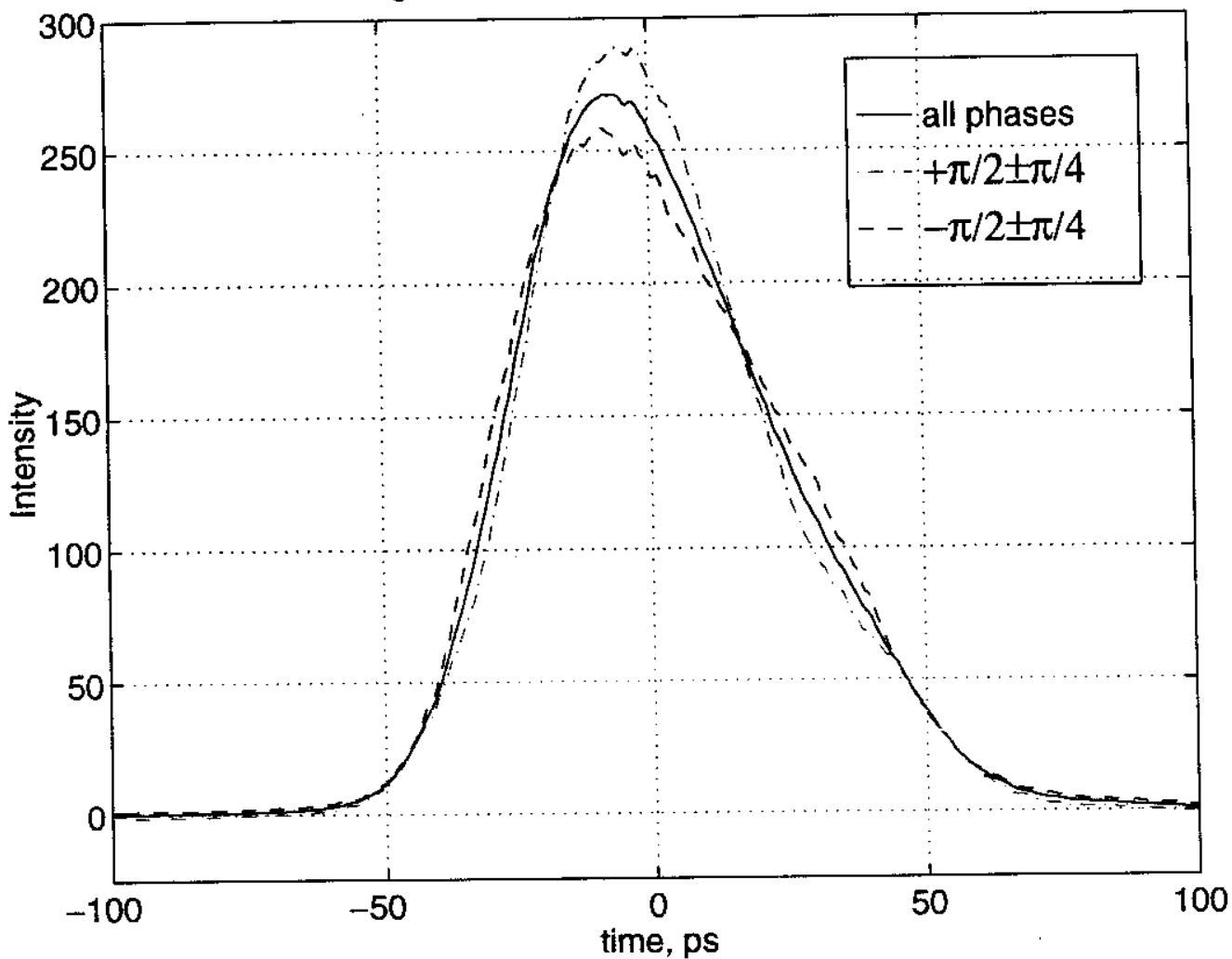

Instability results in $\leq 10\%$ bunch length variation
Quadrupole mode contains $\sim 3\%$ of the beam

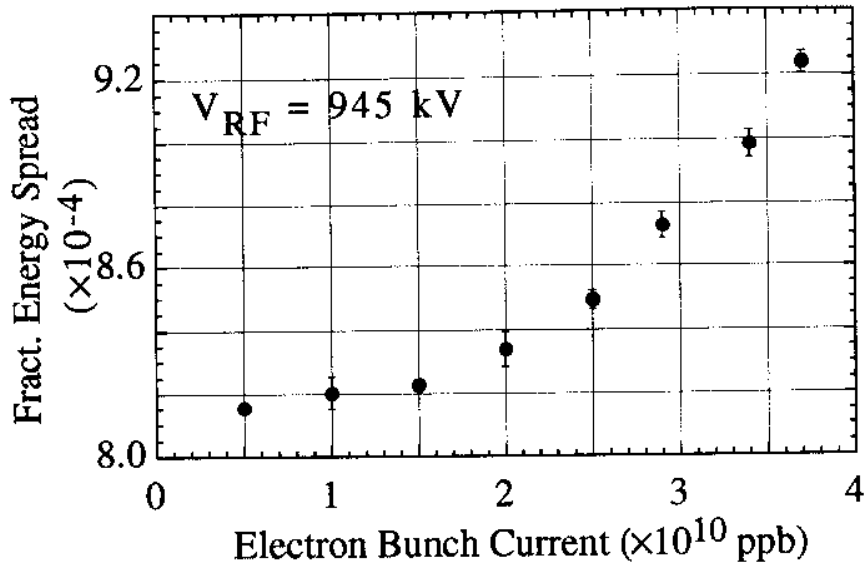

SLC
 DAMPING
 RING (S)
 — IMPEDANCE
 EFFECTS —

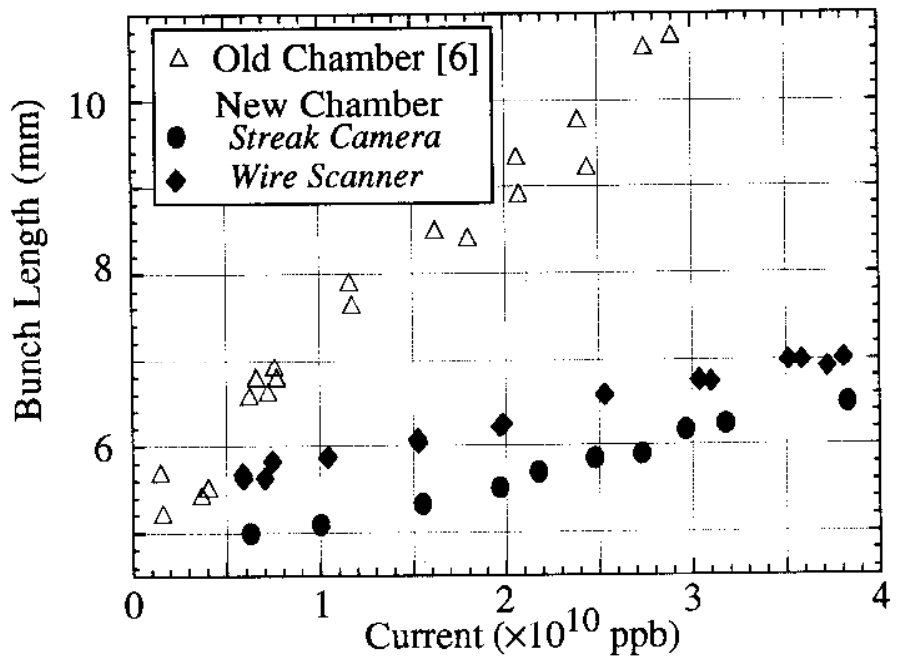

Vacuum Chamber Design

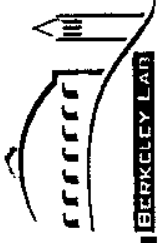

Continuous or discrete photon absorbers?

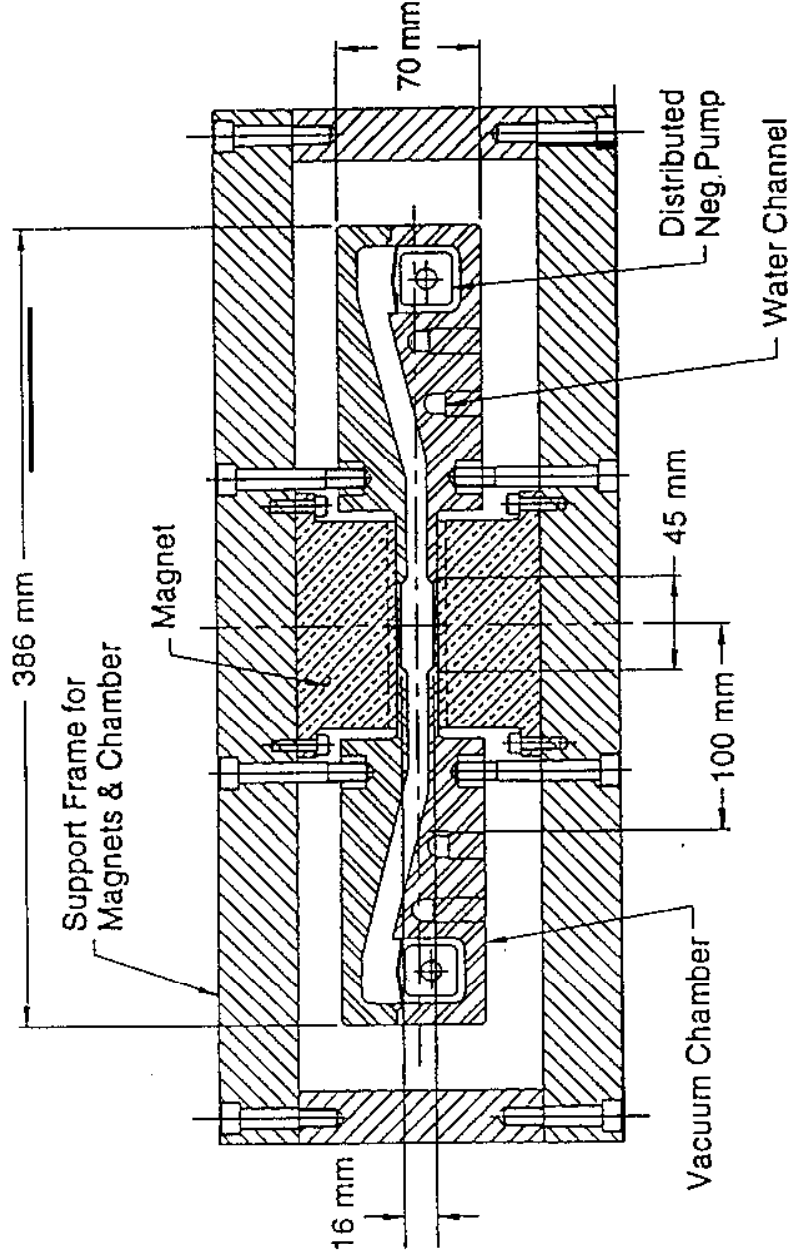

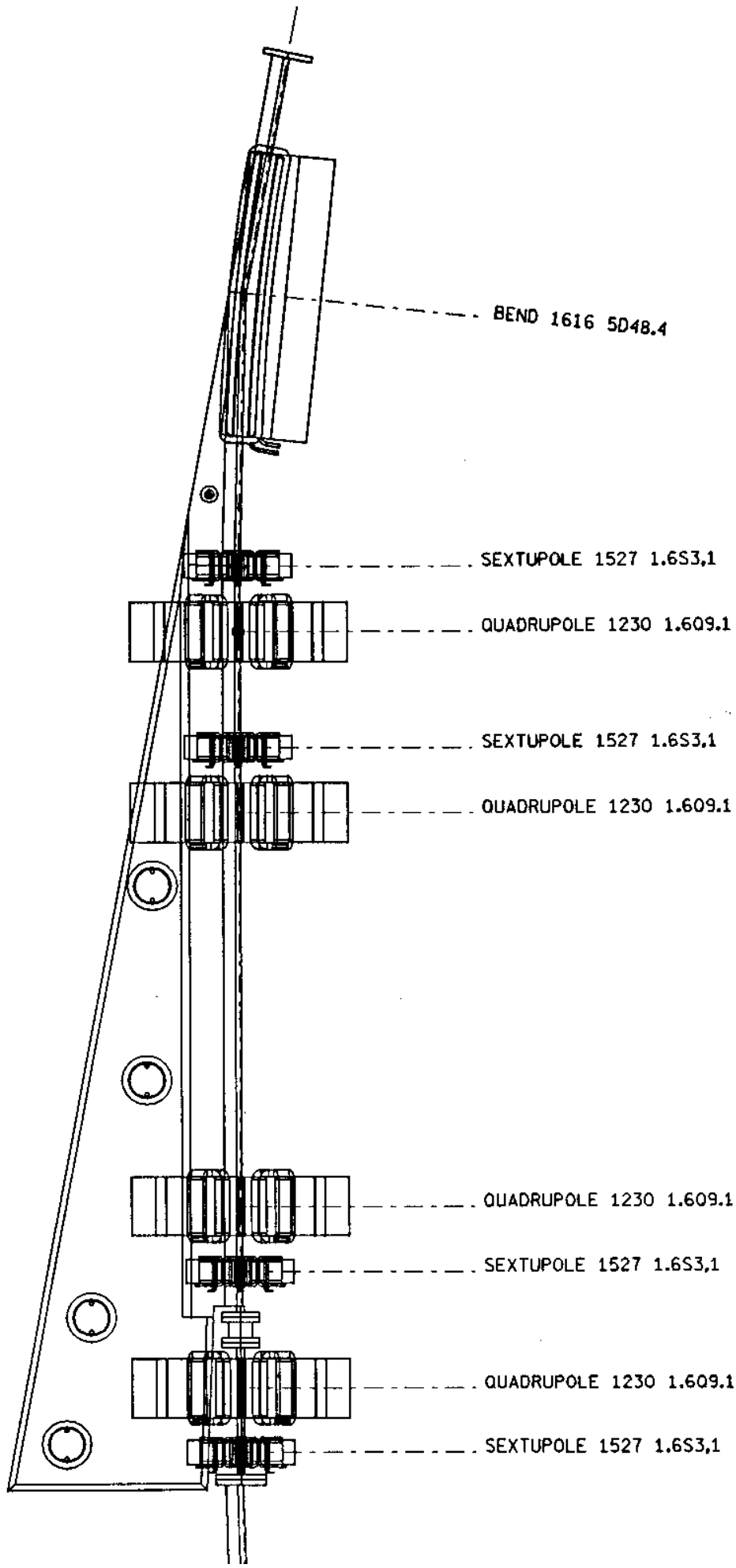

BEND 1616 5D48.4

SEXTUPOLE 1527 1.6S3,1

QUADRUPOLE 1230 1.609.1

SEXTUPOLE 1527 1.6S3,1

QUADRUPOLE 1230 1.609.1

QUADRUPOLE 1230 1.609.1

SEXTUPOLE 1527 1.6S3,1

QUADRUPOLE 1230 1.609.1

SEXTUPOLE 1527 1.6S3,1

Vacuum system comparison

	Spear 3	NLC	SLC DR	ALS	Spear 2	APS	Bessy	HER	LER	PEPI
E(GeV)	3	2	1.2	1.7	3	1.9	7	9	3.1	15
I (mA)	500	800	136.2	500	200	400	300	3000	3000	92
CIRCUMFERENCE -- TOTAL (M)	234	295	35	197	234	1104	240	2200	2200	2200
DIPOLE BEND RADIUS (M)	7.5	5.8	2	4	12.7	38.9	10.3	165	30.6	165.5
NO. BEND MAGNETS	34	32	40	24	36	80	32	192	192	192
POWER PER BEAM (KW)	478	230	13	115	113	1,639	36	10,557	802	2,490
KW PER METER PER DIPOLE (KW)	2	1	0.4	0.6	0.5	1.5	0.1	4.8	0.4	1.1
	14.1	7.2	0.3	4.8	3.1	20.5	1.1	55	4.2	13
PHOTON DESORPTION (MOL/PHOTON)	2.00E-06	2.00E-06	2.00E-06	2.00E-06	2.00E-05	2.00E-06	2.00E-06	2.00E-06	2.00E-06	2.00E-05
GAS LOAD (T./S)	7.00E-05	7.74E-05	8.00E-06	4.00E-05	3.00E-04	1.00E-04	4.00E-05	1.00E-03	5.00E-04	7.00E-04
DESIGN PRESSURE (TORR)	5.00E-10	1.00E-09	1.00E-09	1.00E-09	1.00E-08	1.00E-09	2.00E-09	1.00E-08	5.00E-09	2.00E-08
PUMP SPEED REQUIRED	145,440	77440	7,990	36,845	29,088	101,808	20,604	130,896	90,173	33,451
Actual pump speed (arc)	622	397	227	187	124	92	86	173,760	42,240	165,000
PUMP SPEED/METER								59	41	15

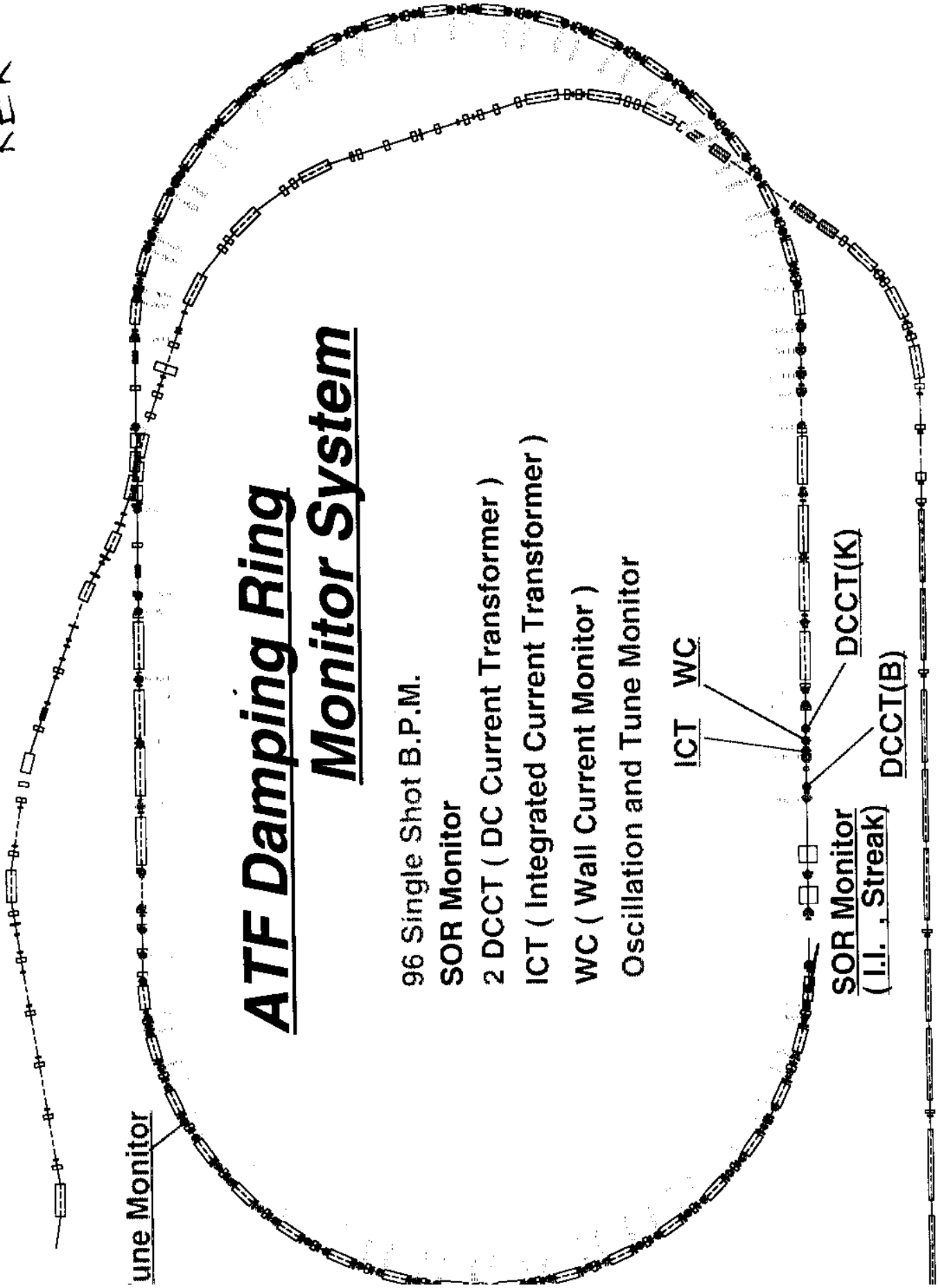

ATF Damping Ring Monitor System

- 96 Single Shot B.P.M.
- SOR Monitor
- 2 DCCT (DC Current Transformer)
- ICT (Integrated Current Transformer)
- WC (Wall Current Monitor)
- Oscillation and Tune Monitor

Tune Monitor

ICT WC

DCCT(K)

DCCT(B)

SOR Monitor
(I.I. , Streak)

ATF Damping Ring Parameters:

	Design	Achieved	SLC
Energy(GeV)	1.54	1.28	1.19
Circum.(m)	138.6		35
$\gamma\epsilon_x$ (m-rad)	4.3e-6 (1.3GeV)	3.4e-6	3e-5
$\gamma\epsilon_y$ (m-rad)	3e-8	1.1e-7	1e-6
ϵ_x (m-rad)	1.7e-9	1.37e-9	1.3e-8
ϵ_y (m-rad)	1.2e-11	4.4e-11	4e-10
$\gamma\epsilon_z$ (mm)	11	13	16
I (mA)	600	4	150
N (single b)	1-3e10	1e10	4.5e10
τ_b (inter-bunch space)	2.8 (ns)	-	61.625/ 58.823
N_b	20		
T_b	60		
N trains	4		
$\tau_x/\tau_y/\tau_z$ (ms)	6.8/9.1/5.5 (wiggler)	19.5/29.9/ 20.6	3.5 (x/y)
rep-rate (Hz)	25	1.5	120
V_c (MV)	.59	.3	.8
U_0 (KeV)	155		90
α_p	.002		.02
σ_z (mm)	5		7

Emittance measurements (x)

Accelerator	Lattice	Energy (GeV)	Design ϵ_x (nm)	Design $\gamma\epsilon_x$ (μm)
SLC DR	FODO	1.19	13	30
ELETTRA	DBA	2.0	7.0	27
ESRF	DBA	6.0	3.5	41
APS	DBA	7.0	8.5	116
Spring-8	DBA	8.0	6.4	100
BESSY-II	TBA	1.5	6.1	17.9
ALS	TBA	1.7	3.6	11.9
ATF	FOBO	1.28	1.35	3.38
NLC DR	TME	1.98	0.8	3

Typical sizes: $\sigma_x \sim 70\mu\text{m}$ (1/3 SLC damping ring x sizes)

$\sigma_y \sim 15\mu\text{m}$

Beam Size Monitors:

Synchrotron light monitor

Source point parameters (design):

β_x	.8m	β_y	1.4m
η_x	0.048m	η_y	0.004m
σ_x	36 μ m	σ_y	6.2 μ m
res	\sim 40 μ m		\sim 40 μ m

Power dissipation (at typ. I) \rightarrow 2W

C layer damage problems

(several different mirror types tested)

Imprecise knowledge of source point parameters

Extracted beam wire scanners

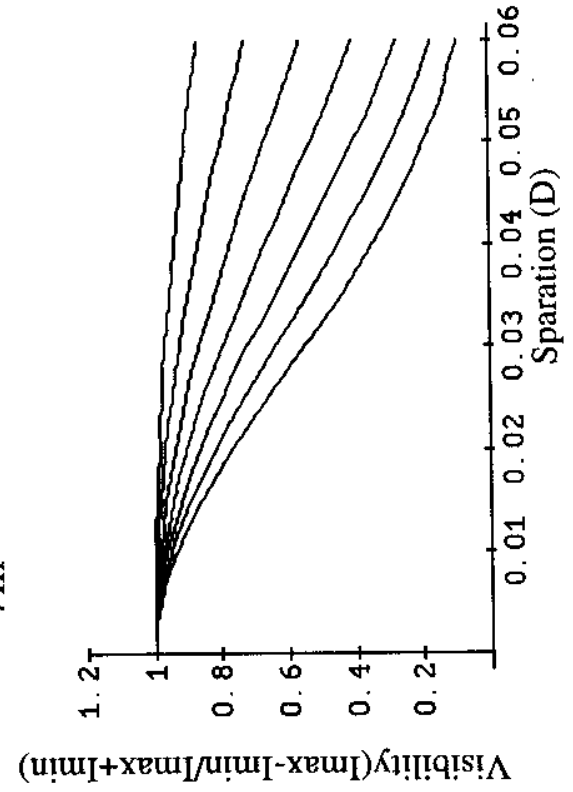
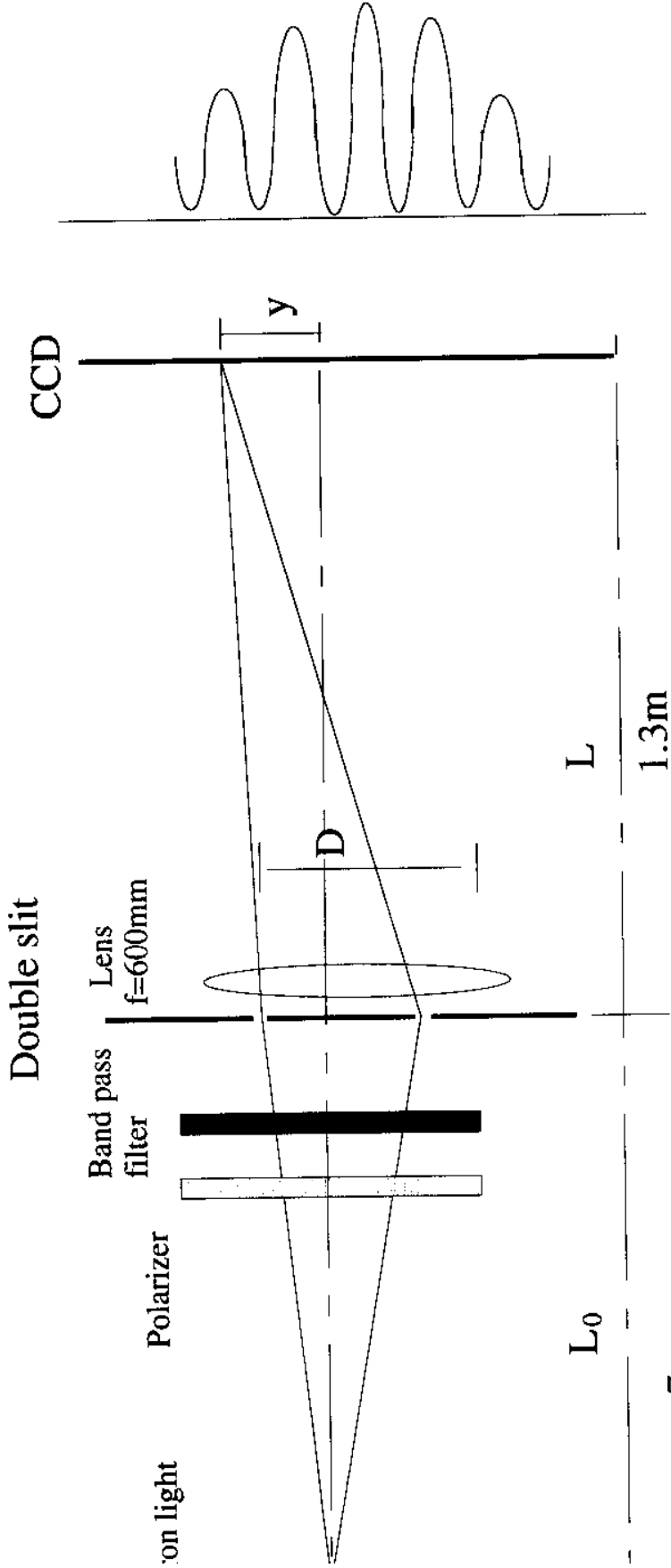

Interferogram

$$I = \pi a J_0 \left\{ 1 + \exp \left[- \left(\frac{2\pi D a}{\lambda L_0} \right)^2 \right] \right\} \bullet \cos \left(\frac{2\pi D y}{\lambda L} \right)$$

Layout of the SR-interferometer

ATF DR Emittance measurement by SR-interferometer

11 / 20 / '98

Vertical

4 / 27 / '98

horizontal

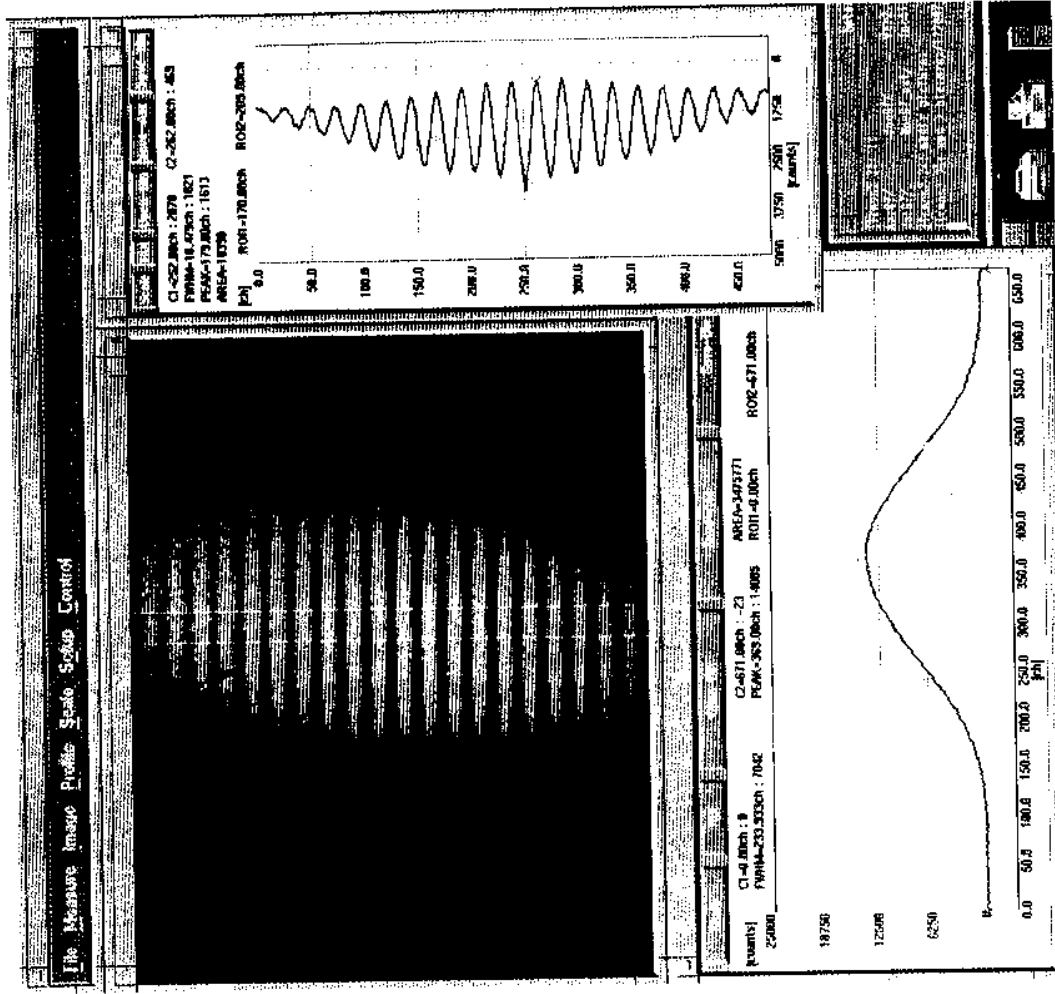

$$\sigma_y \leq 6.9 \mu\text{m} \quad \epsilon_y \leq 0.8 \times 10^{-11} \text{m}$$

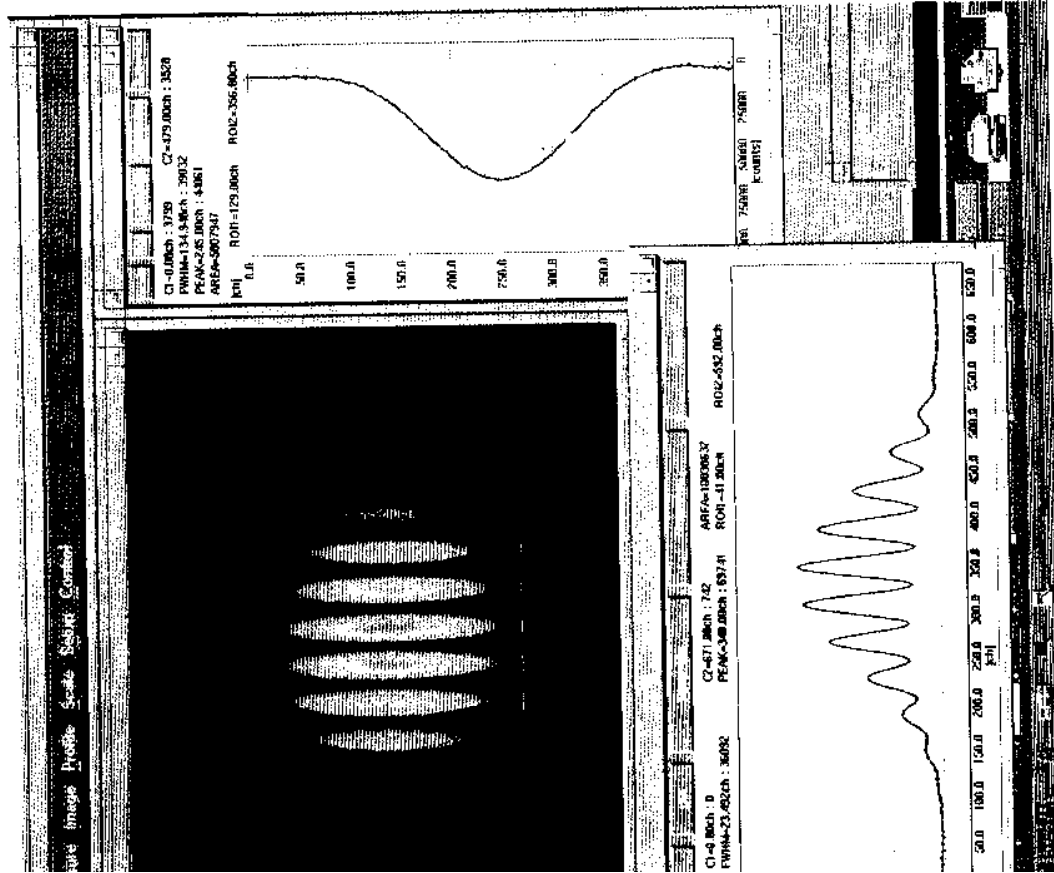

$$\sigma_x \leq 39 \mu\text{m} \quad \epsilon_x \leq 1.3 \times 10^{-9} \text{m}$$

2) Dispersion Measurement

OKUGI

We usually measured a dispersion function at Wire Scanner by Wire Scanner itself.

Measured Dispersion at the end of 1998 run

	Horizontal	Vertical
MW0X	110 mm (66.0 μm)	20 mm (12.0 μm)
MW1X	81 mm (48.6 μm)	18 mm (10.8 μm)
MW2X	20 mm (12.0 μm)	23 mm (13.8 μm)
MW3X	58 mm (34.8 μm)	20 mm (12.0 μm)
MW4X	51 mm (30.6 μm)	18 mm (10.8 μm)

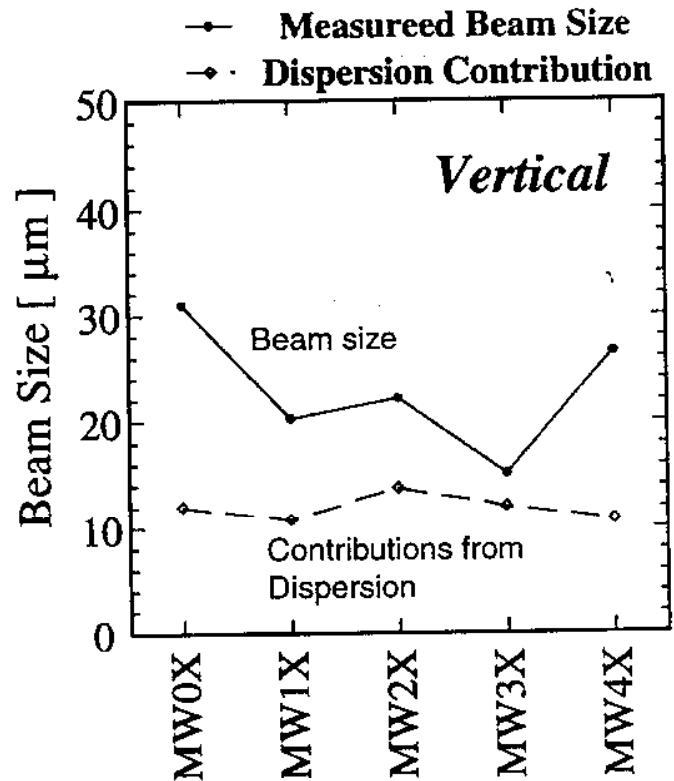
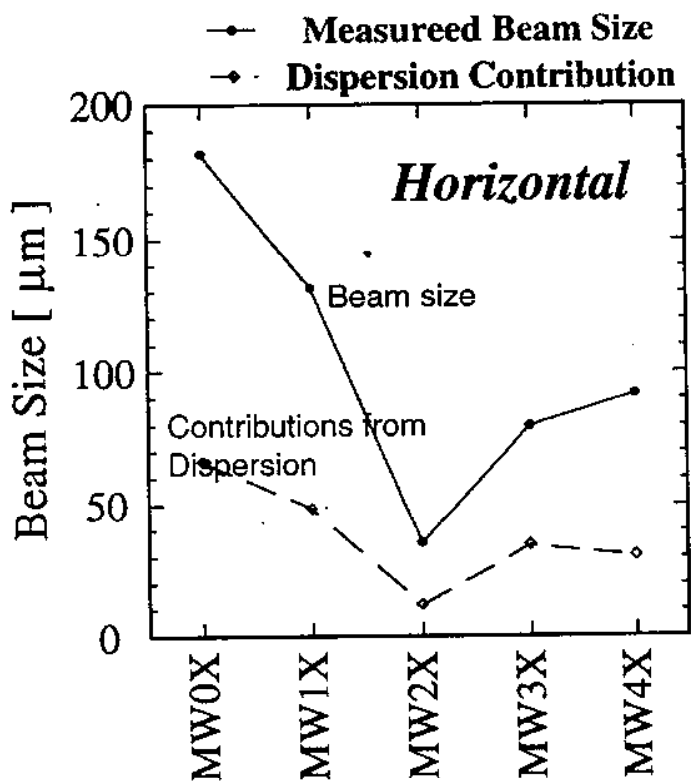

ϵ_x
Horizontal

ϵ_y
Vertical

w/o Disp. Data	1.618 ± 0.252 nm	0.0571 ± 0.0048 nm
with Disp. Data	1.364 ± 0.246 nm	0.0497 ± 0.0031 nm

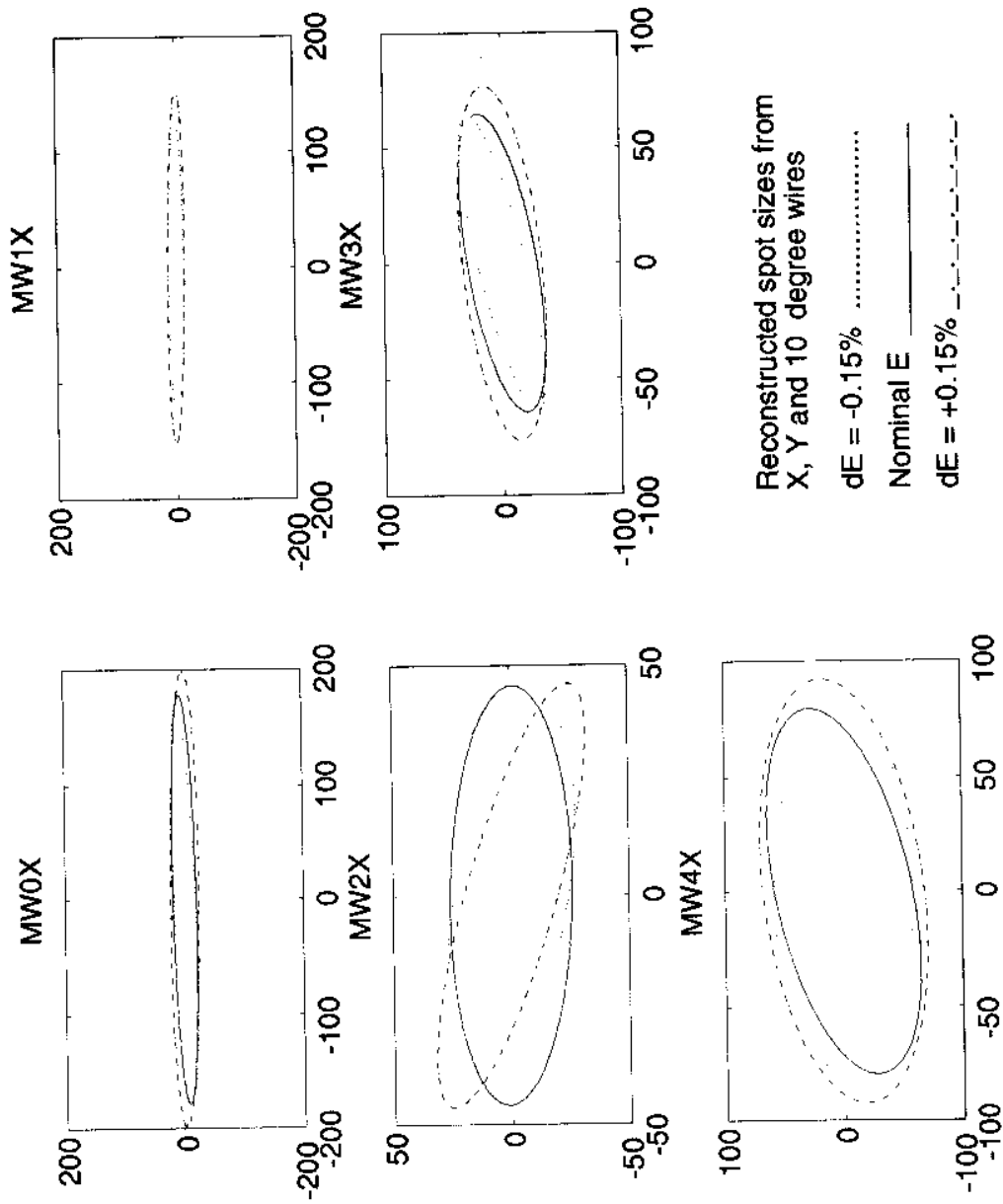

Beam profiles at wire scanners for different energies. Axis units are microns.

NLC
DESIGN -

SKEW
CORRECTION
+

MEASUREMENT

~ 30 m long @
1.5 GeV

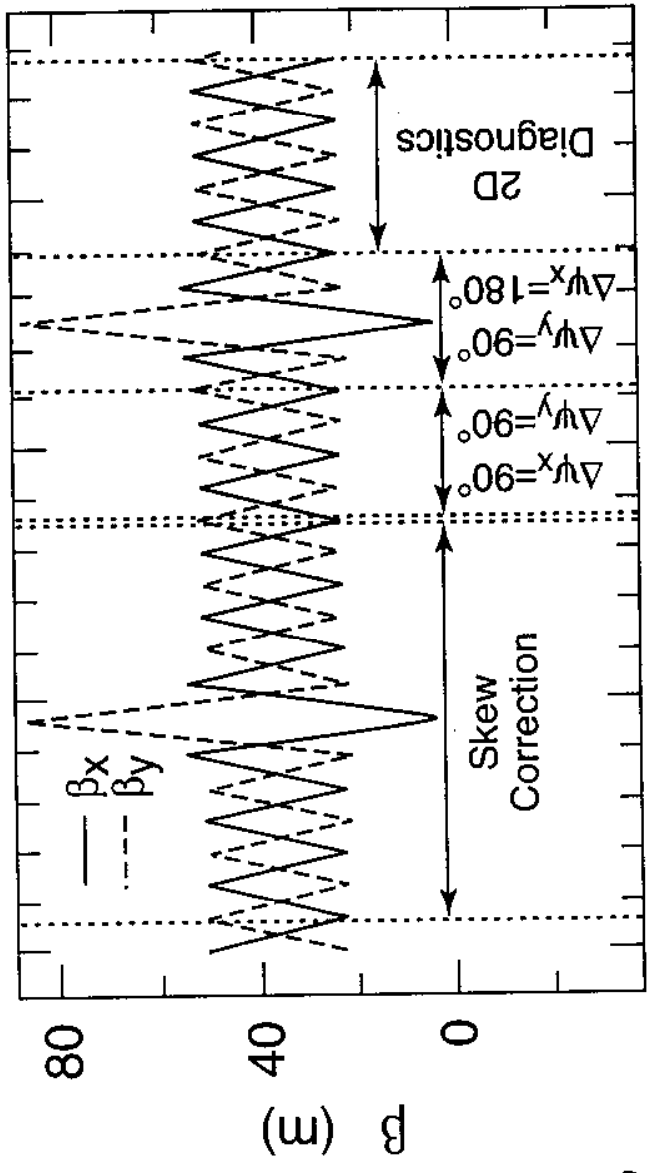

CLEAN
1 → 1
CORRECTION

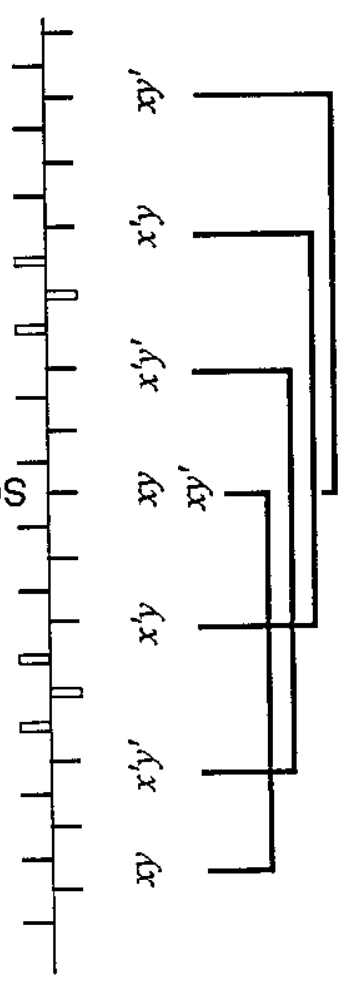
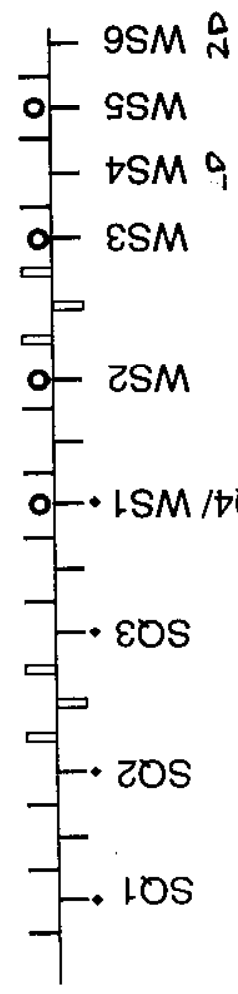

ZDR-EMMA

SLC WIRE SCANNERS

Parameters and locations for the critical SLC emittance scanners. The scanners are listed roughly in the order that the beam passes them during routine operation. Typical SLC beam intensities for 1994 - 1998 operation are 3.5×10^{10} particles/bunch with a bunch length of 1 ± 0.5 mm resulting in peak currents of 2 kAmp. The wire material is tungsten except as noted.

Location	Number	Wire diameter (μm)	Wires	expected beam size	Number of scans/device	Purpose
RTL - ϵ	2	40	x, y, u	200 x 50 μm	80000	Beam size
Linac S2	4	40(20y)	x, y, u	300 x 30 μm	140000	Emittance
Linac S28	4	40(20y)	x, y, u	200 x 40 μm	150000	Emittance
FF (e+/e-)	10	15-40 & 34 C	x, y	10 - 200 μm	15000	Emittance
Other	36	50-500		.3mm - 3mm	430000 (total)	Emittance, energy spread and optical parameters
Total	56			Total no. scans	1930000	(age varies from 3 to 7 yr.)

Laser-based beam profile monitors:

Tested at SLC inside SLD 1996 – 0.5 μ m resolution

Beyond the resolution of synchrotron light
Beyond the melting point of wires

Use short pulses ~ 10 MW focused to ~ few λ

Behaves ‘like a wire’

Finite length (Rayleigh length ~ few 10’s λ
‘Thickness’ can be controlled

Allows additional flexibility

Multi-bunch lasers
Polarimetry
Fast scanning

Conclusion

Short pictures of NLC supporting technology – tilted towards controls; injector issues

Demonstrations exist across a broad range of engineering

CDR preparation begun.

SLC Laserwire IP

t

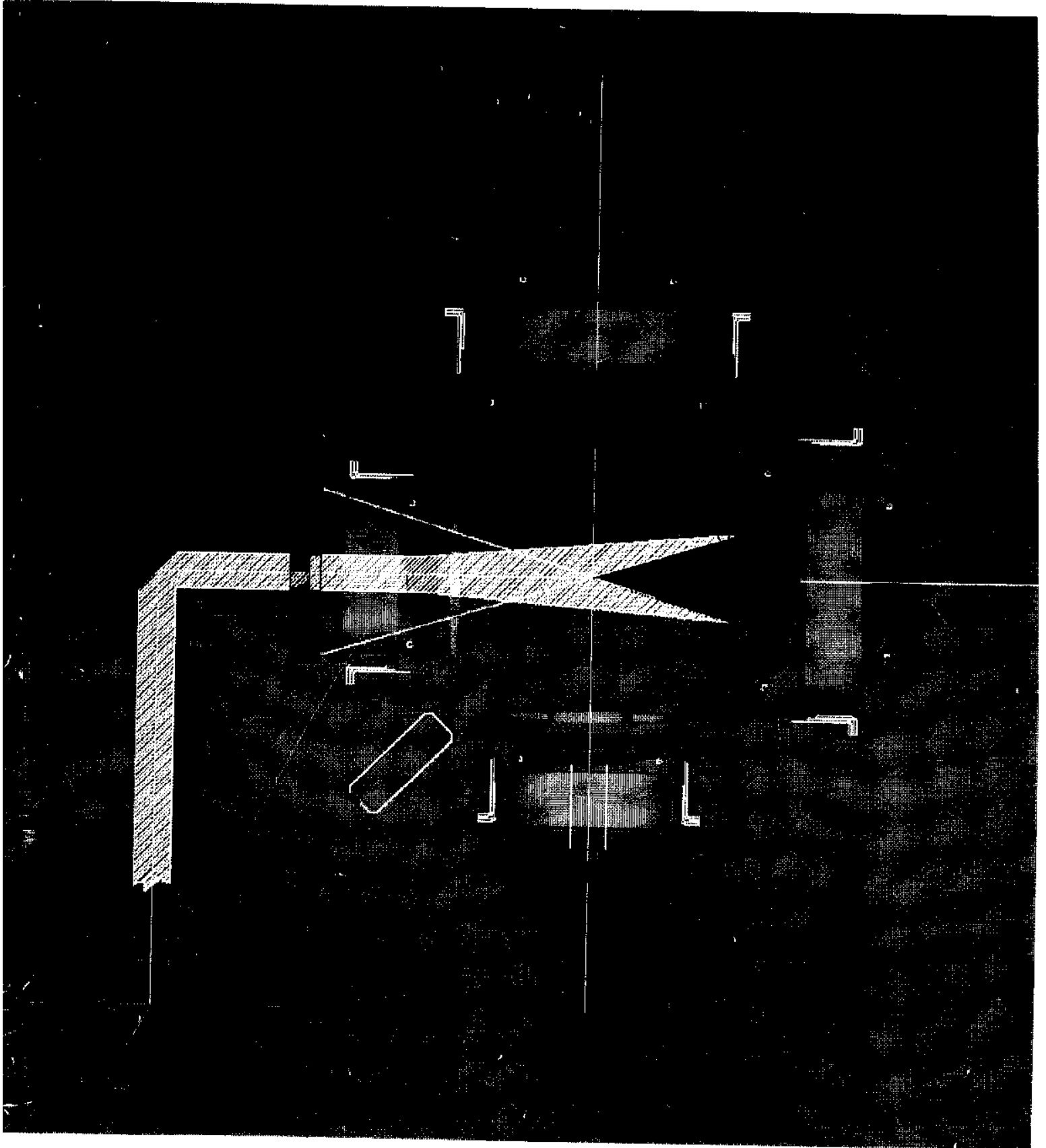

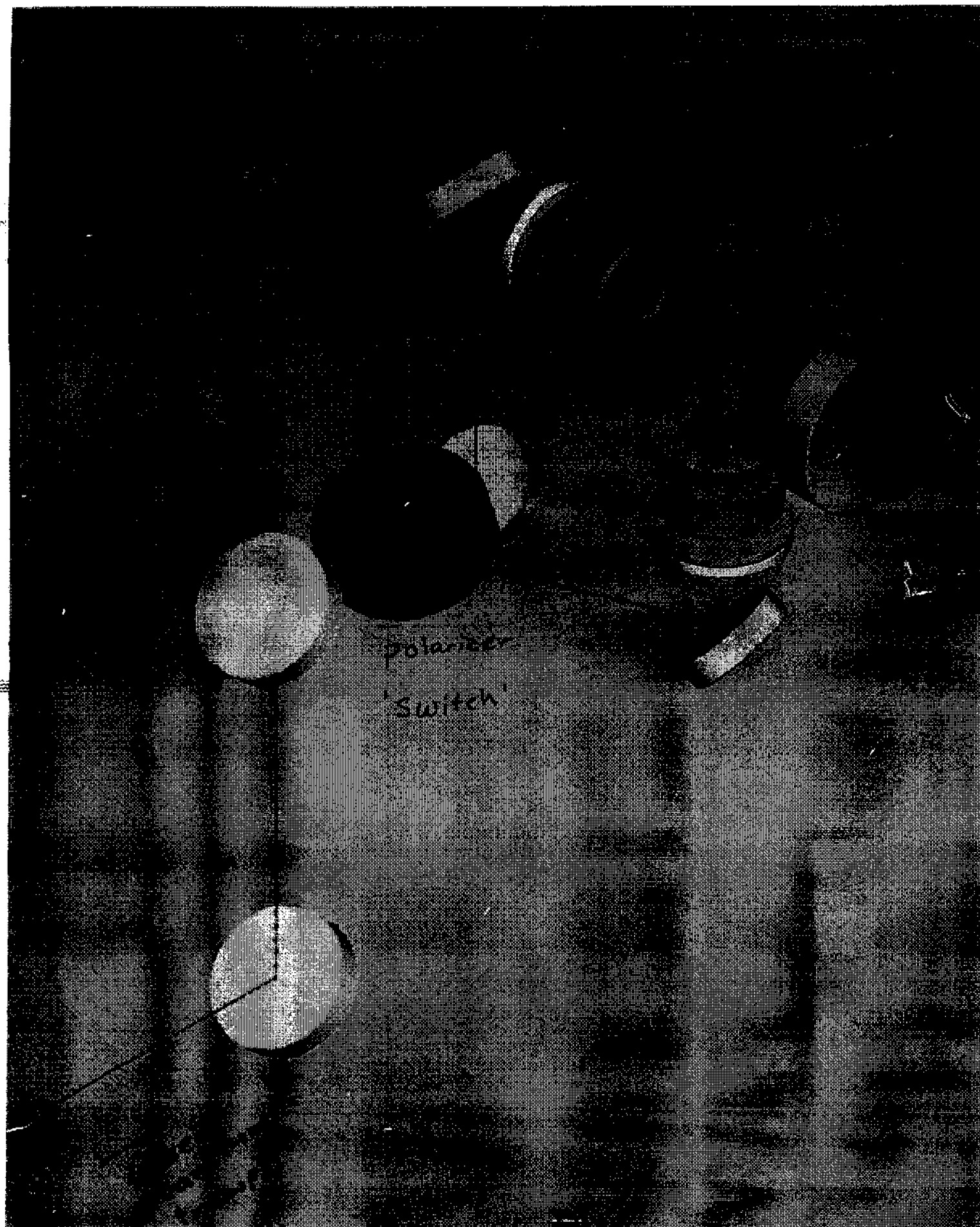

polarizer
switch

$$A + B \cdot \exp(-X \cdot C \cdot Y^2 / 2 \cdot D^2)$$

CHISQ/NDF = 179

Typical Nom. I

Scan $4 \times 10^{10} e^-$

$$\sigma_s = 1.36 \mu m$$

$$\sigma_s^2 = \sigma_L^2 + \sigma_{e^-}^2$$

\sim degraded $e^-/2$

$$A = 113 \pm 0.175$$

$$B = 652 \pm 0.79$$

$$C = 1.016 \times 10^{-03}$$

$$D = 1.36 \pm 1.947e-03$$

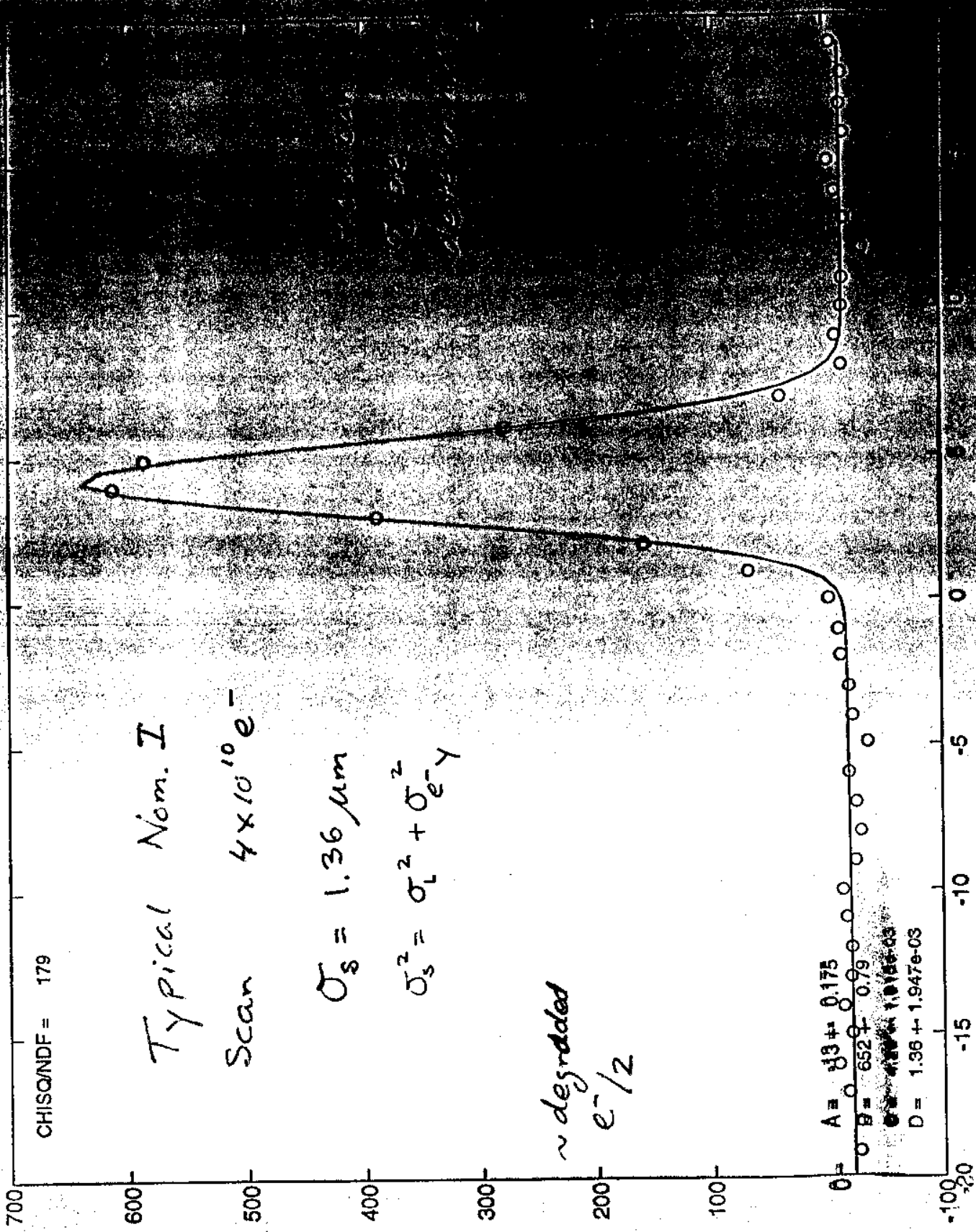

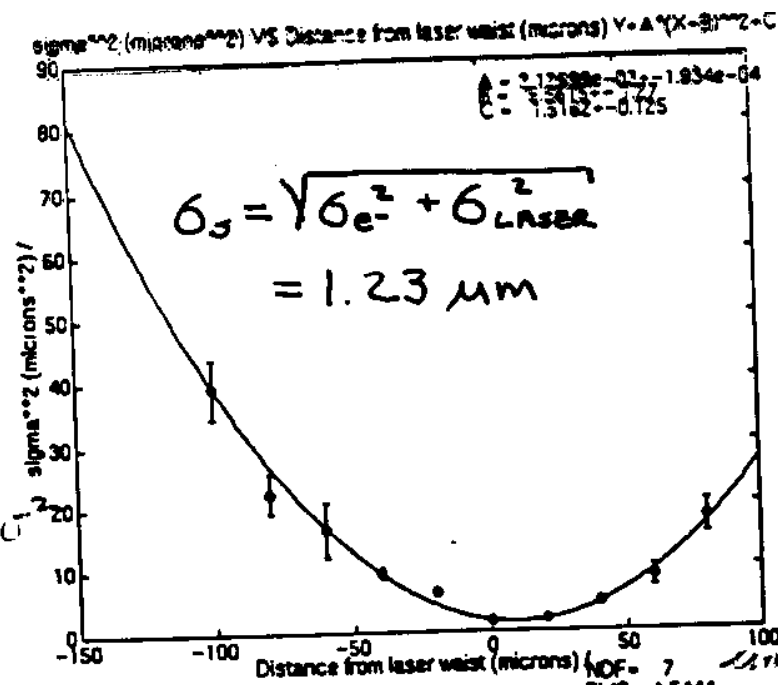

JLC LASER WIRE
Optimization
Scans

LASER BEAM WAIST

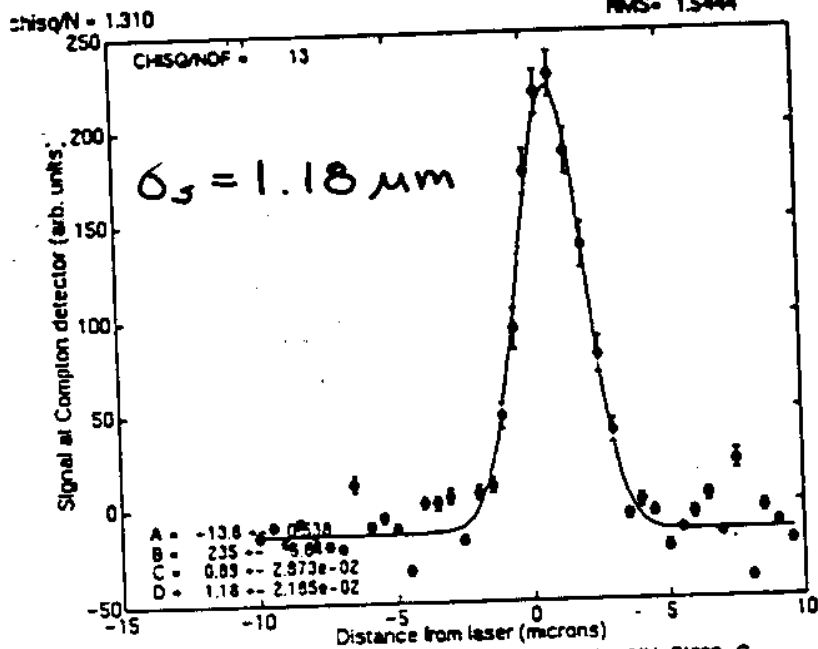

SINGLE SCAN

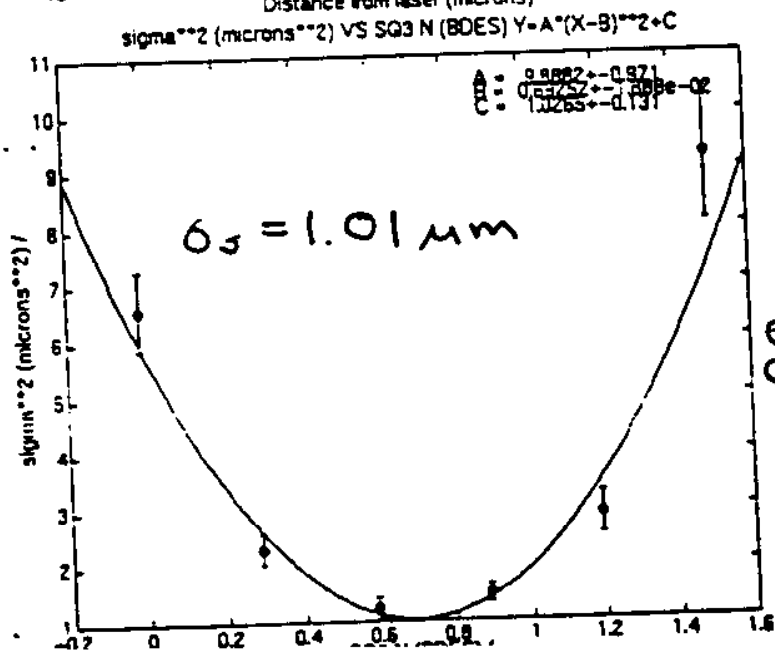

e- BEAMLINE
OPTIMIZATION WITH
LASER-WIRE

→ Next connection

Laserwire

e^+/e^- beam

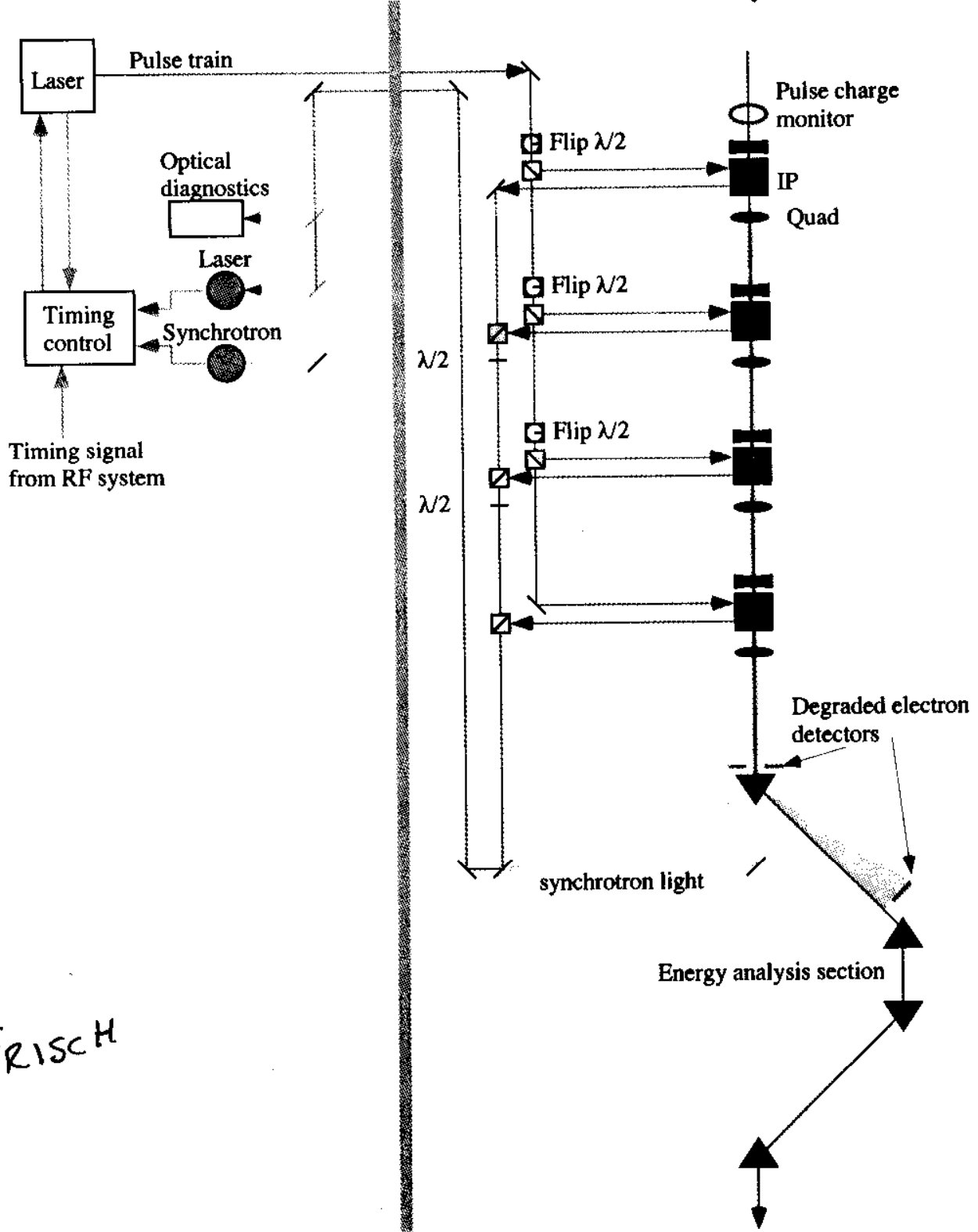

FRISCH

LASERWIRE IP

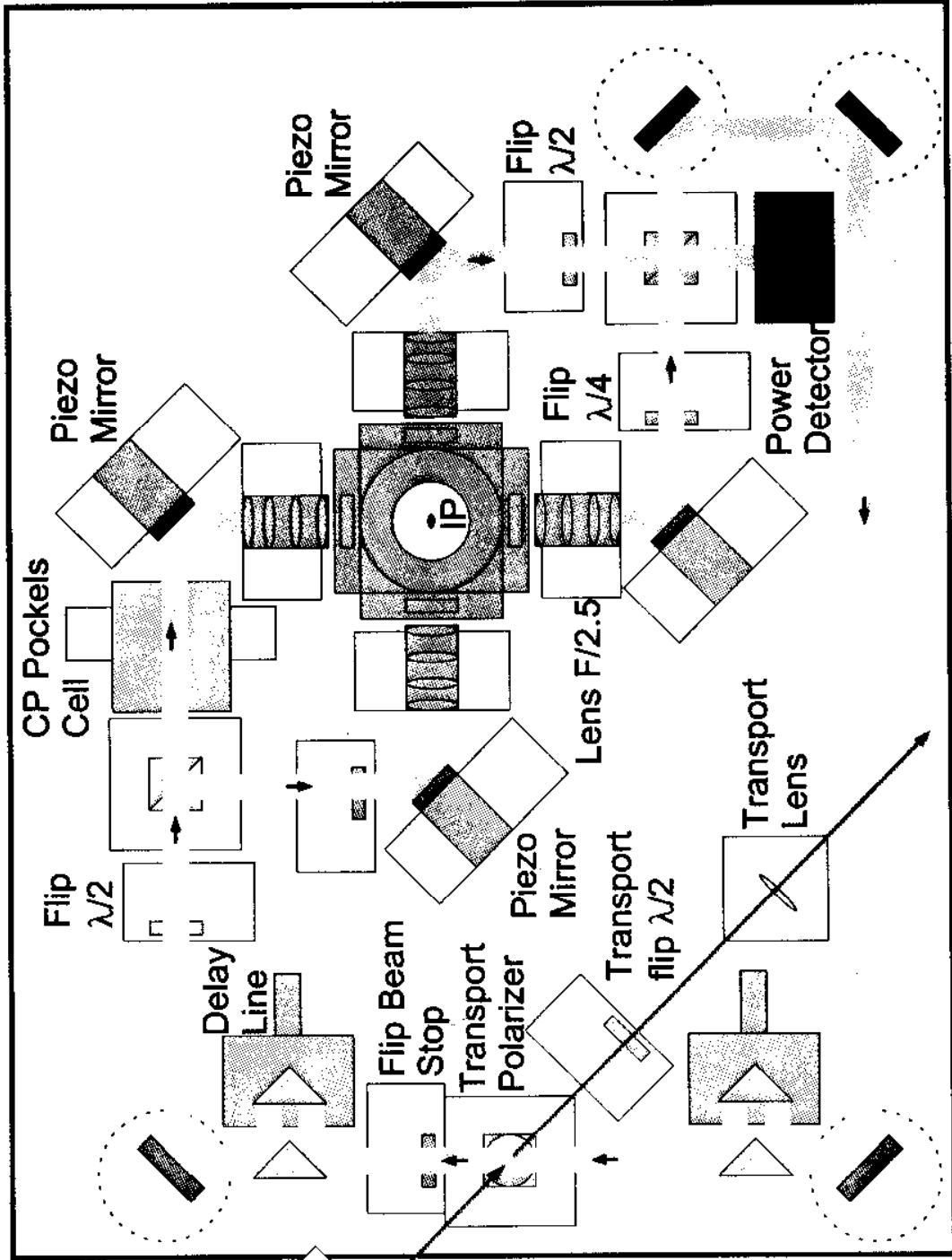

Transport-
Flip $\lambda/2$ (out
of plane)

Optical Table 18" X 24"

ASSET

X-band accelerator structure test bed

Drive – probe beam technique

- Uses SLC rings
- cleanly damped
- can independently control timing and trajectory
- Drive beam easily dumped – opposite polarity

Successful validation of structure design details:

Dipole mode damping:

Long and short range wake tests

Use of the dipole mode to align trajectory through the structure

Accelerator Structure Wake Test "ASSET"

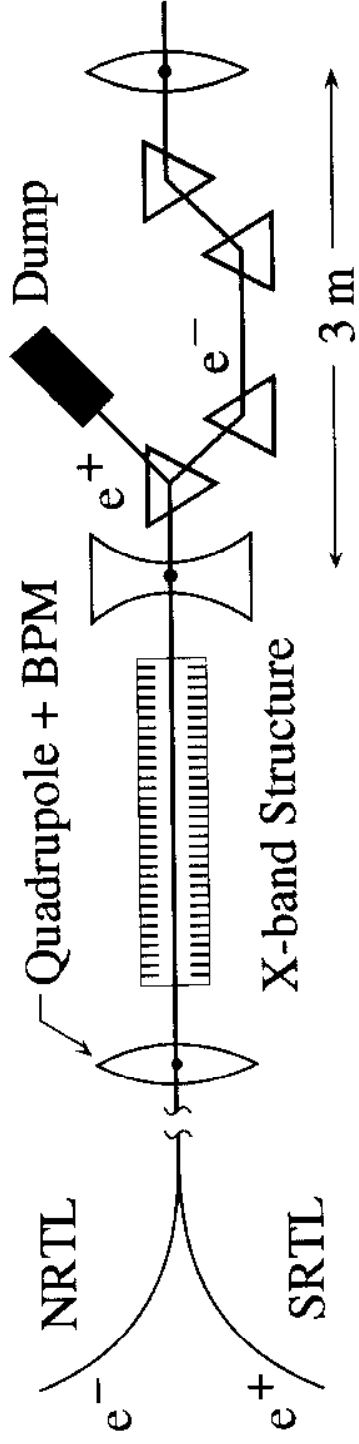

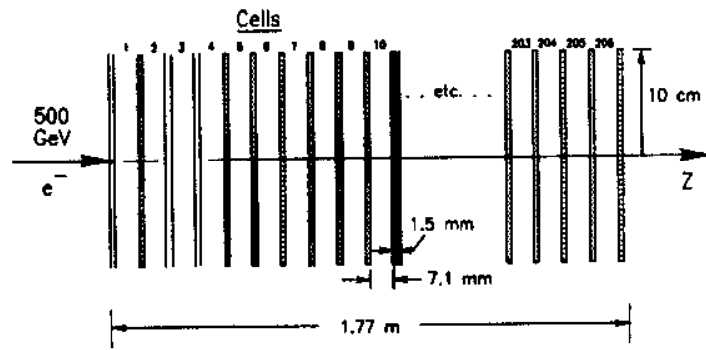

Geometry used for EGS shower MC simulation - without 'cut off' iris

Cut-Away View of the Damped and Detuned Structure (DDS)

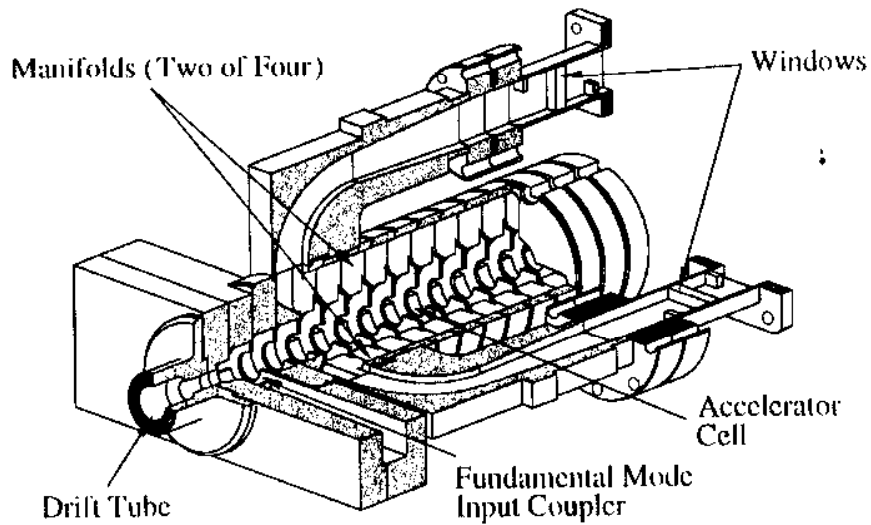

Spot Sizes: \square -10 μ \ast -20 μ \circ -30 μ \square -50 μ

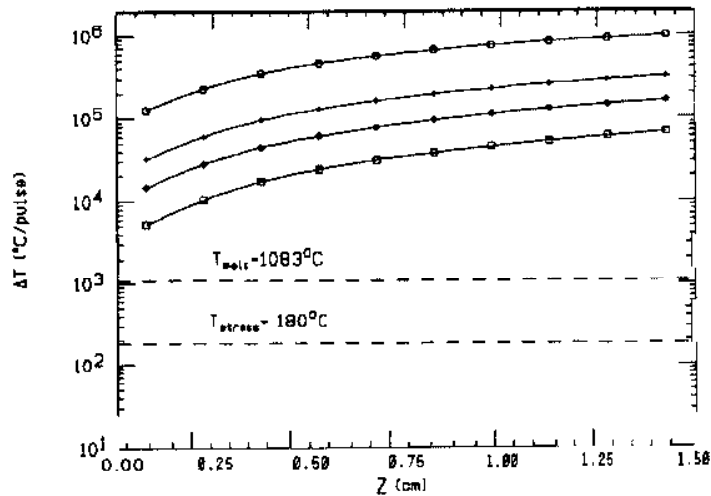

Maximum temperature rise within the first (15-mm thick) 'cut off' iris.

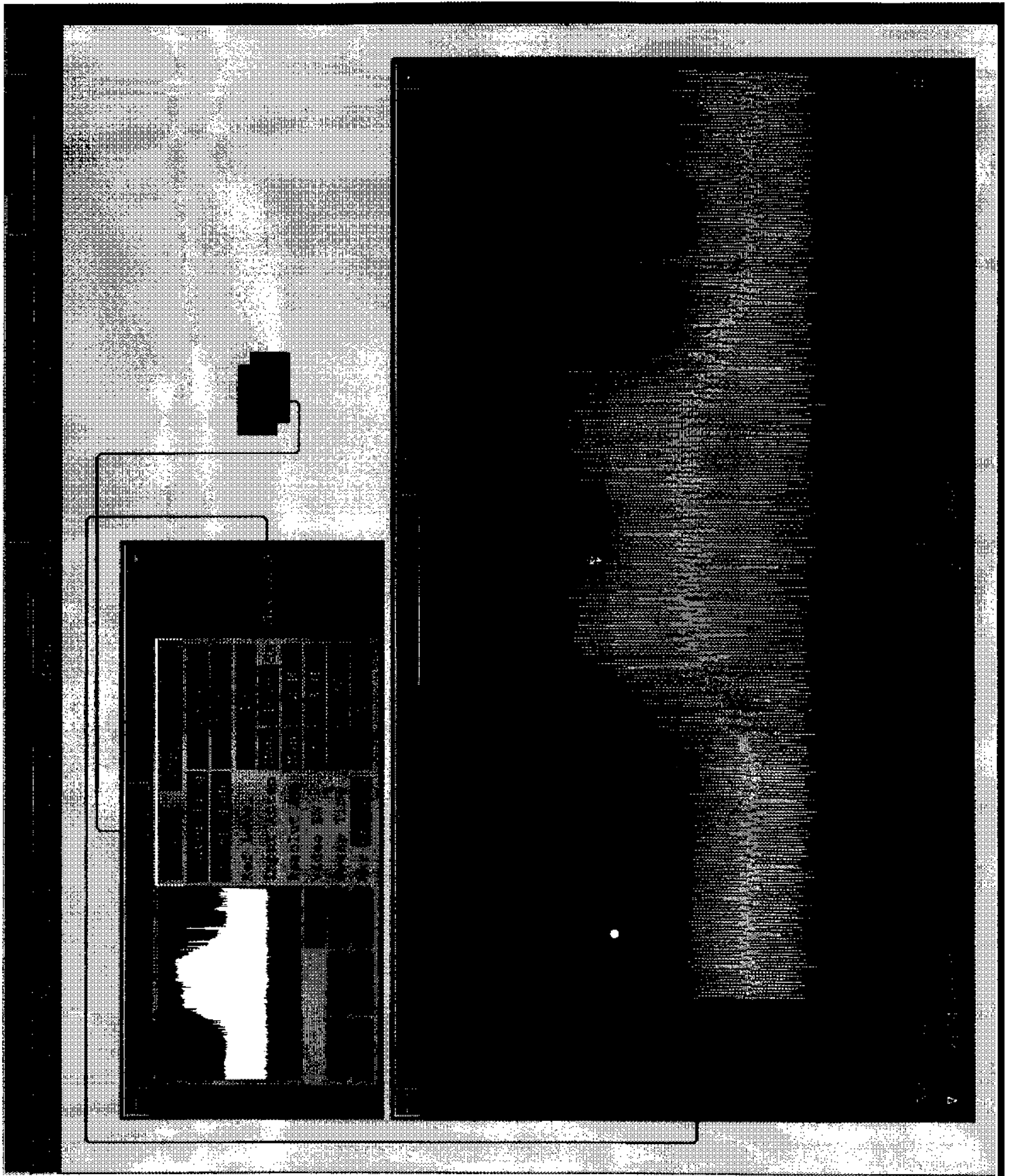

DDS 3 Cell-to-Frequency Mapping

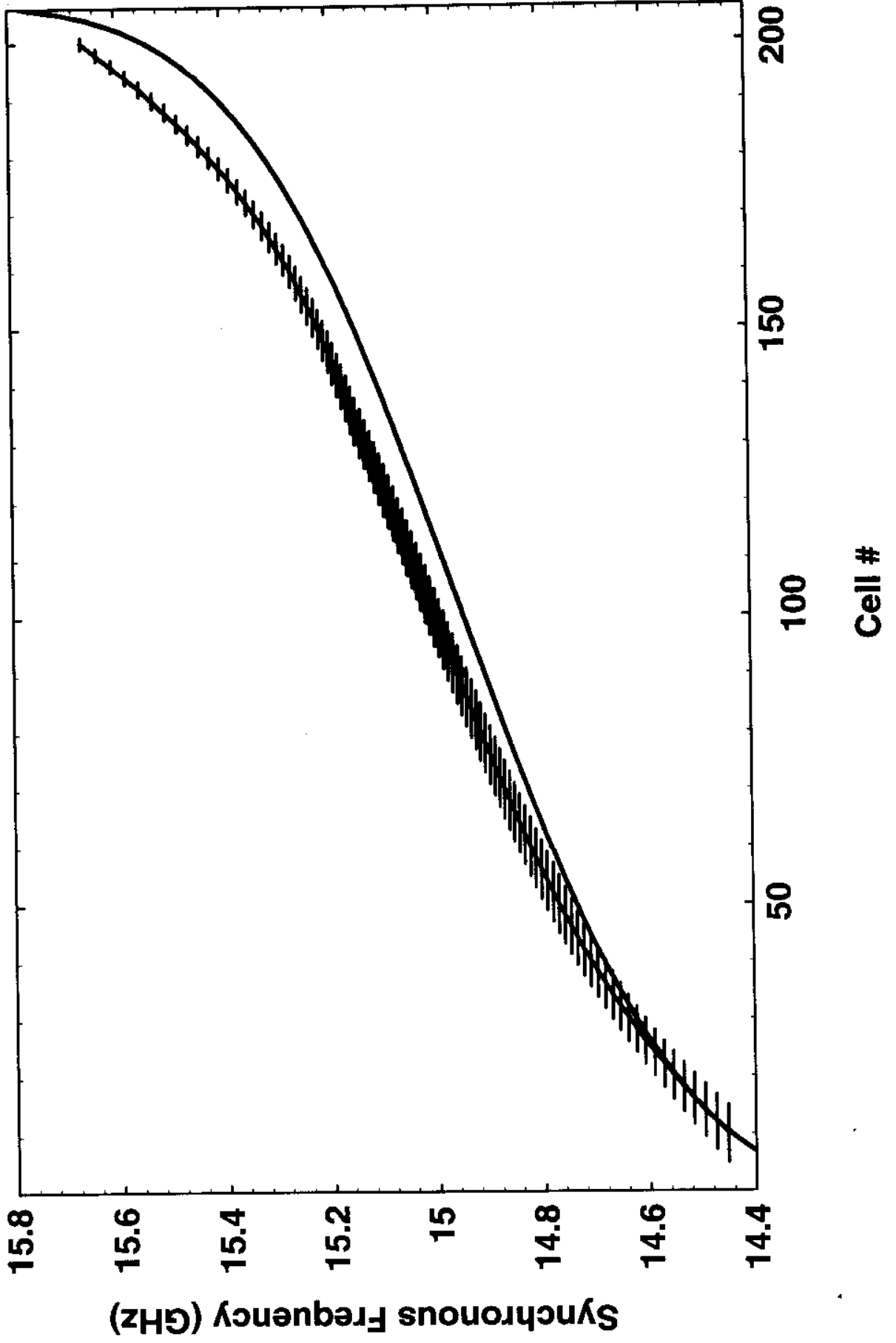

rf_dat_18: freq = 14.3 (GHz), Min Power = 84.9 (microns)

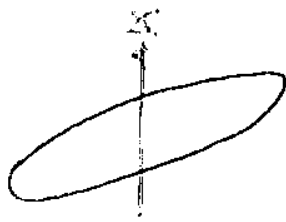
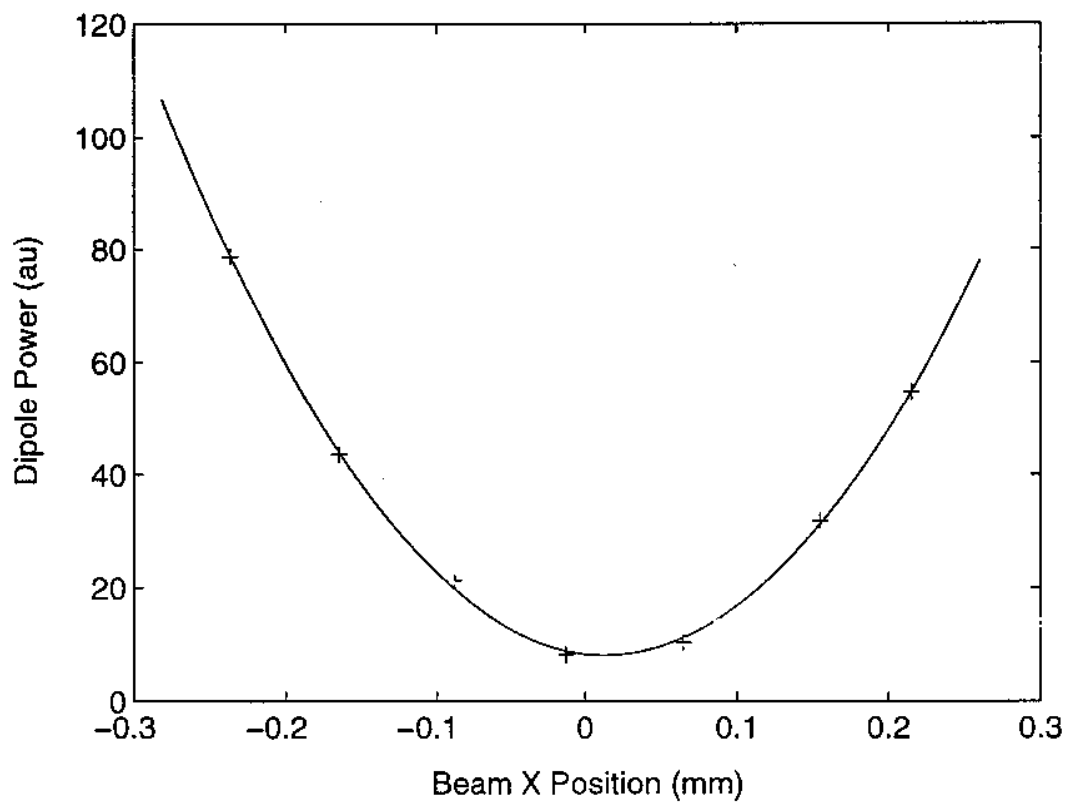

$$\text{if } \langle X \rangle = \alpha z / \sigma_z$$

Then MIN power $\sim \alpha / 5$

X-Z CORRELATION

e⁺ Beam Size AT WS148

Before
η ADJUSTMENT

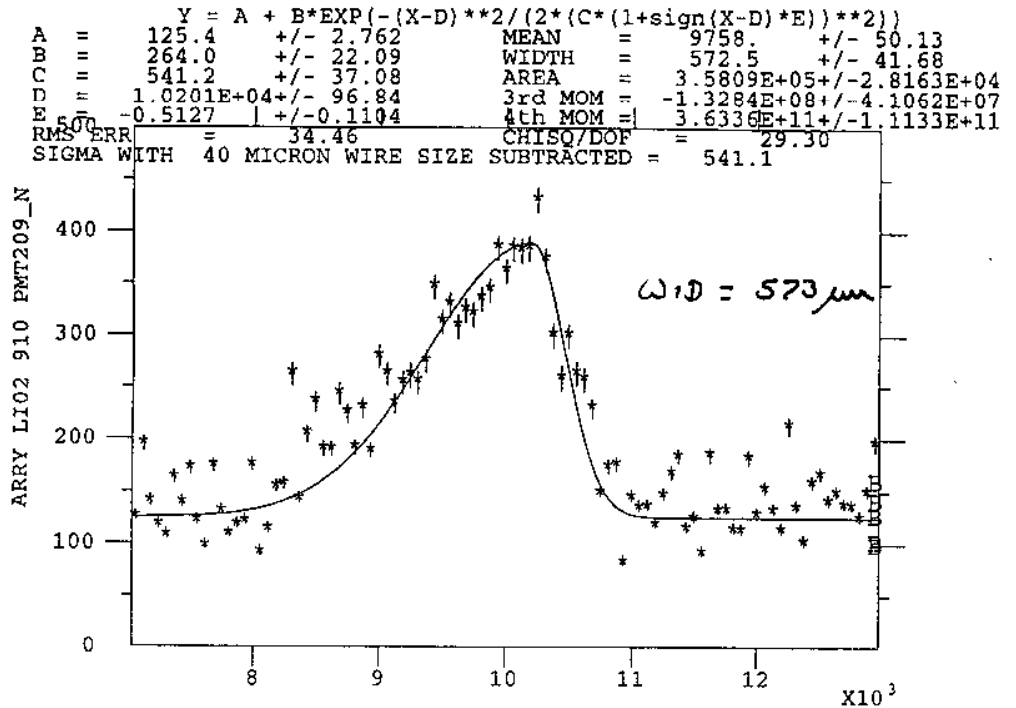

STEP VARIABLE = ZERO
Time Data Was Taken: 9-DEC-1998 18:13:34

9-DEC-98 18:14:26

After
η ADJUSTMENT

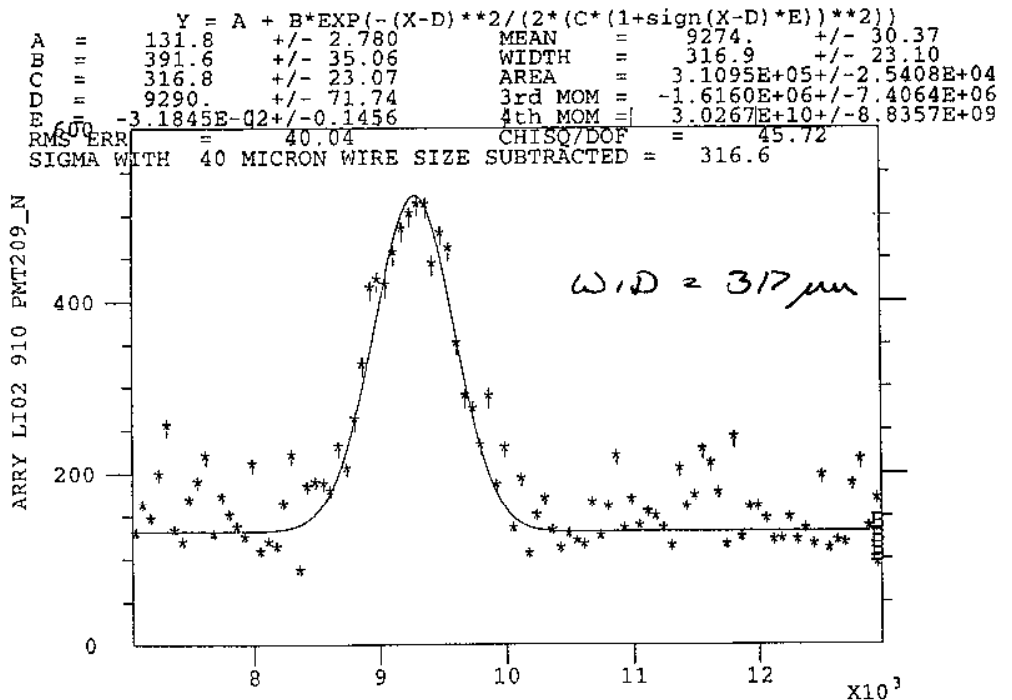

STEP VARIABLE = ZERO
Time Data Was Taken: 9-DEC-1998 18:59:09

9-DEC-98 19:04:02

15 GHz Dipole Signal Power and Phase

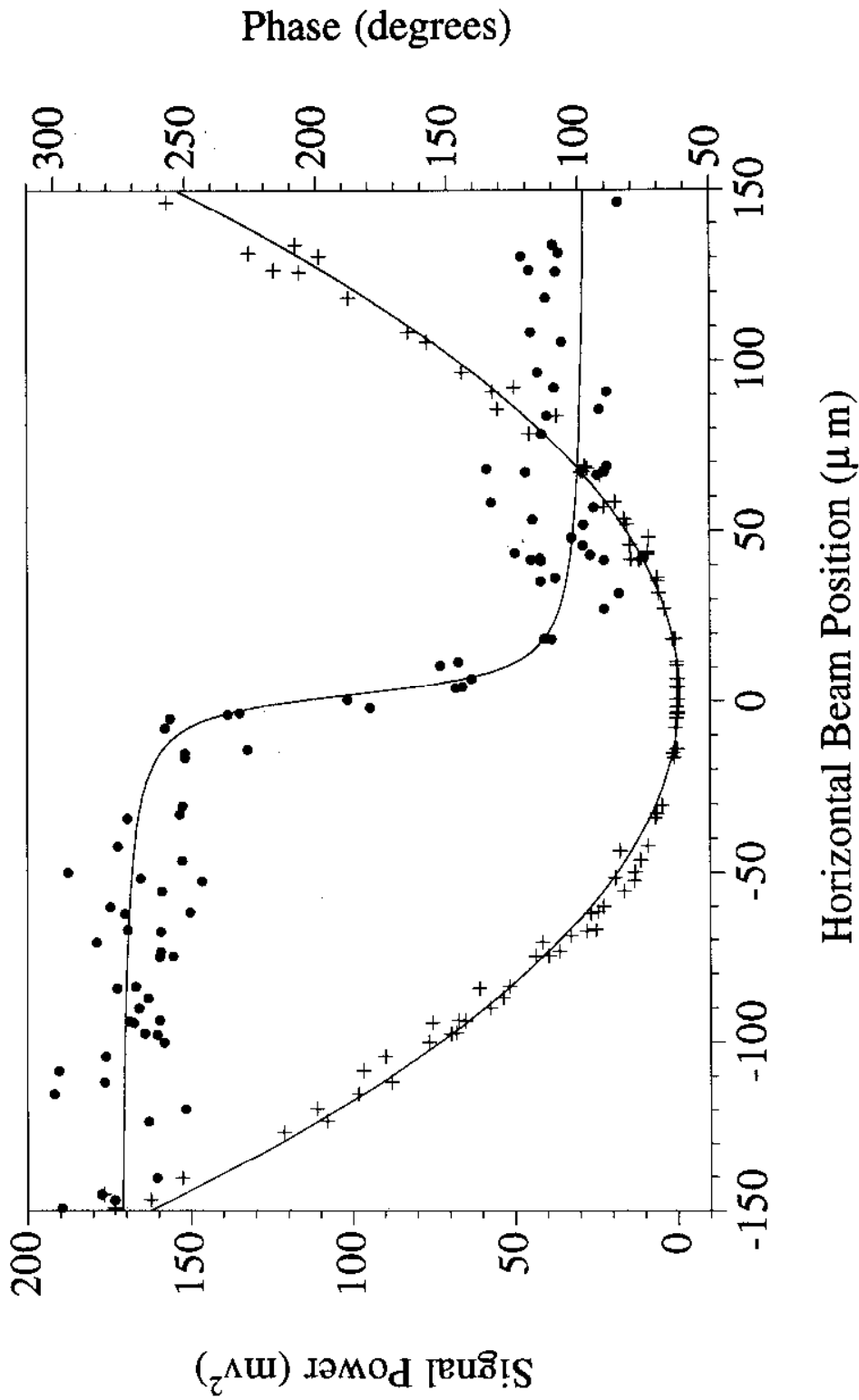

Structure Straightness

Horizontal CMM Data (solid line) and
Beam X Positions at Minimum Dipole Signal Power (data points)

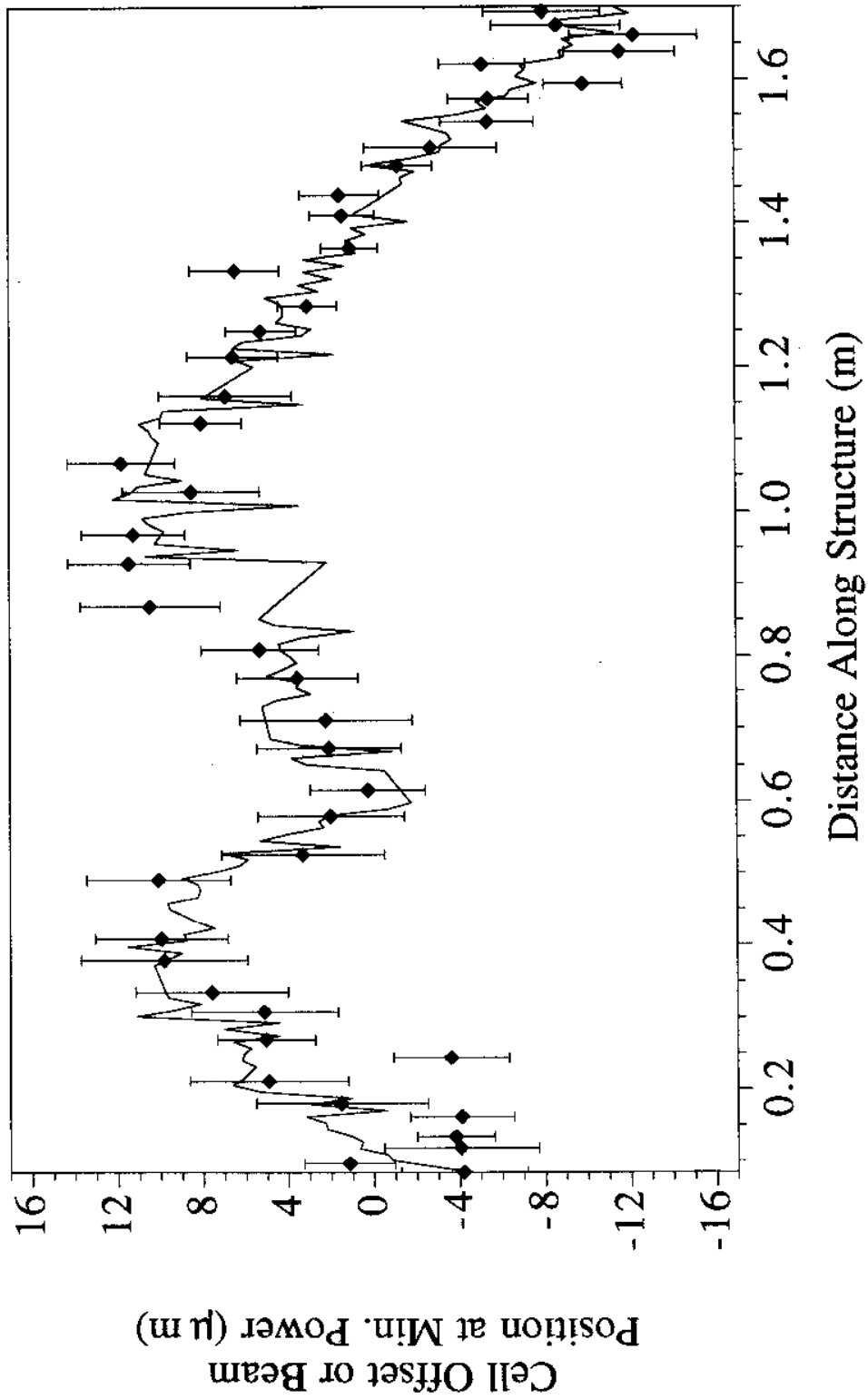

Long-Range Transverse Wakefield of Damped-Detuned Structure #3 (DDS3)

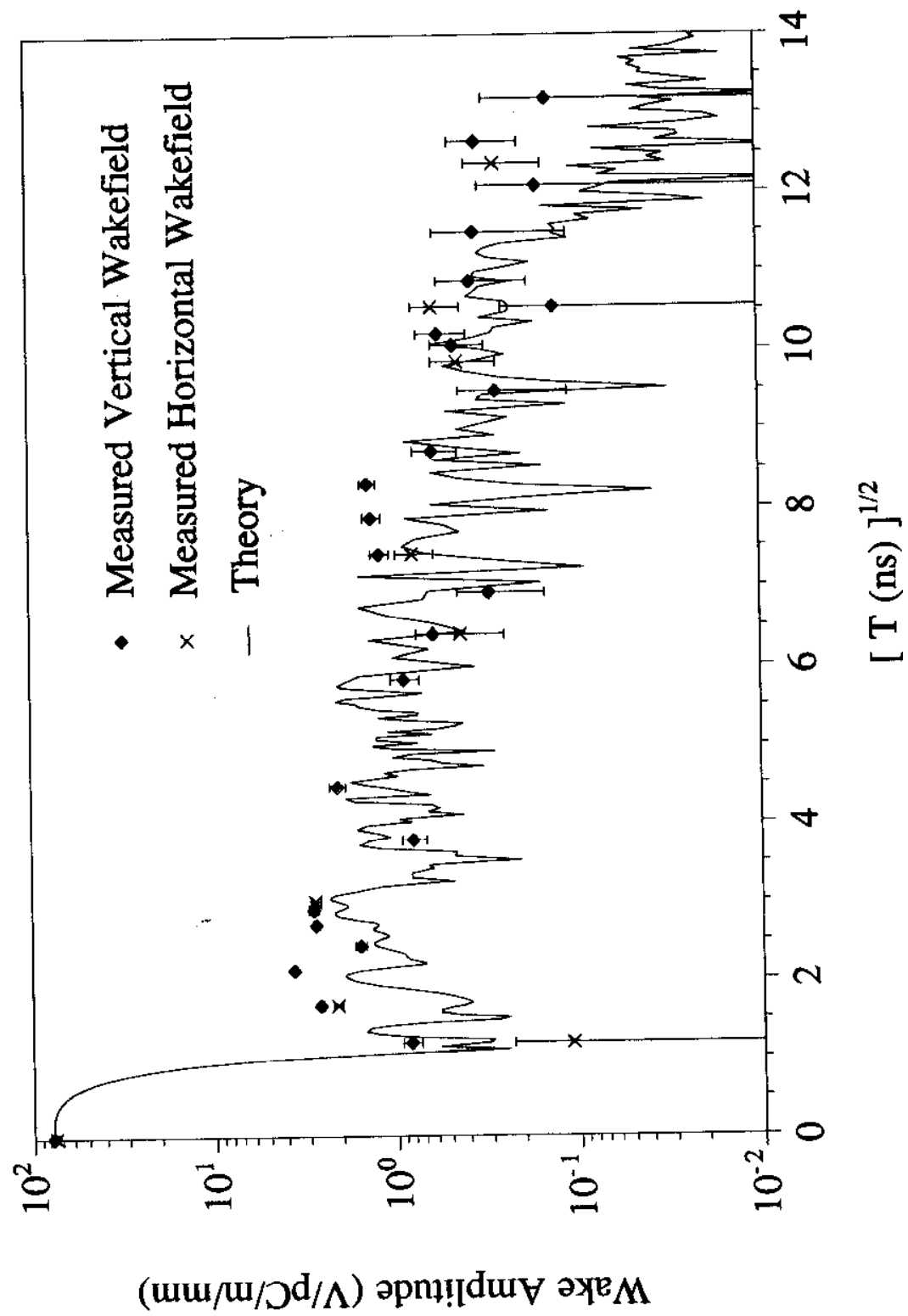

Collimation

Three classes of collimation are considered necessary for the high power beams in the NLC

- Protection of detector from beam halo
 - designed to clip energy and trajectory tails of main particle bunch
 - designed to clip $10 \sigma_x$ by $45 \sigma_y$ tails (nominal beam size of $10 \times 1 \mu\text{m}$ is blown up prior to collimation)
 - note: we have no good model for beam halo -- calculation suggests that tails will be manageable, all experience suggests otherwise
 - may require renewable collimation
 - multi-phase, consisting of a spoiler and dump
- Slightly errant pulse control
 - distributed throughout the system following active components (kickers, compressors)
 - designed to protect downstream accelerator components
 - collimation of energy tails seem reasonable at all energies
 - collimation of betatron motion at $> 10 \text{ GeV}$ may require renewable systems
- Worse pulse
 - designed to be damaged by the beam impact
 - designed to avoid serious damage of various expensive components or a vent of system
 - hope that it can be replaced through a load-lock vacuum isolation system

2 flavors of wakefields which can distort the beam
(short-range wakes):

Geometric Wakefields: Result from changing the shape of the beampipe (going from large-diameter round pipe to small rectangular collimator aperture)

Resistive-Wall Wakefields: Result from finite conductivity of the beampipe

kick $\propto 1/a^3$

tight collimator apertures produce strong resistive-wall
wakefields
are hard to study (usually much smaller than geometric
effects of smoothness are poorly understood

SLC results indicate a resistive wakefield for parallel-plate collimators which is 300% larger than expected!

--> A dedicated facility for collimator wakefield experiments is indicated

beam-pipe transitions
beam-pipe transitions → geometric wakes

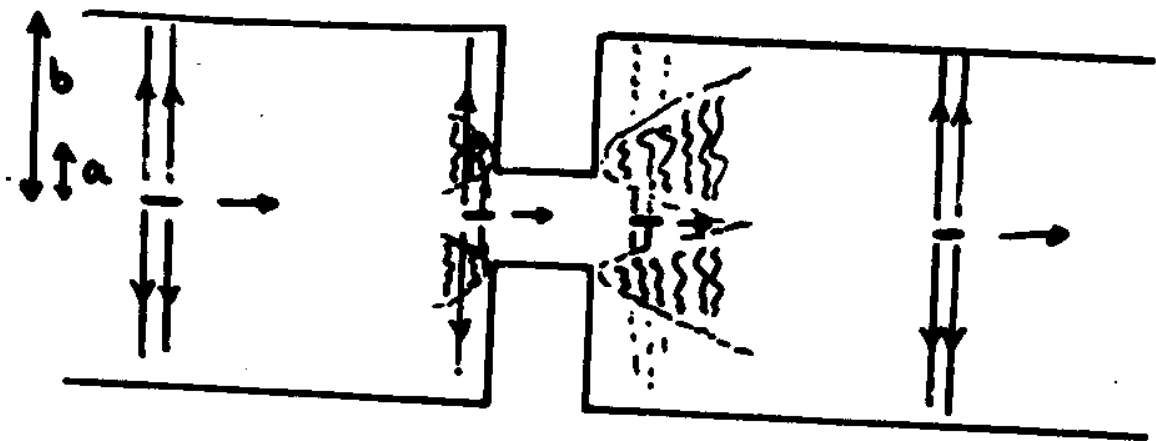

$$\tau_2 \ll a, b$$

energy loss

$$\frac{\Delta E}{E} \approx 1.13 \frac{N r_e}{\gamma \tau_2} \ln \frac{b}{a}$$

transverse kick if off-center

$$\Delta y' = \frac{2 N r_e}{\gamma} \left(\frac{1}{a^2} - \frac{1}{b^2} \right) y$$

also resistive-wall wake close to wall

fitted Kick angle vs collimator position

full gap = 500 μ m
 V coating

θ' (rad)

COLL28_9Y_05MM_7.MAT, N=0.53+-0.01E10, E=45.0 GeV (20-MAY-1997 22:34)

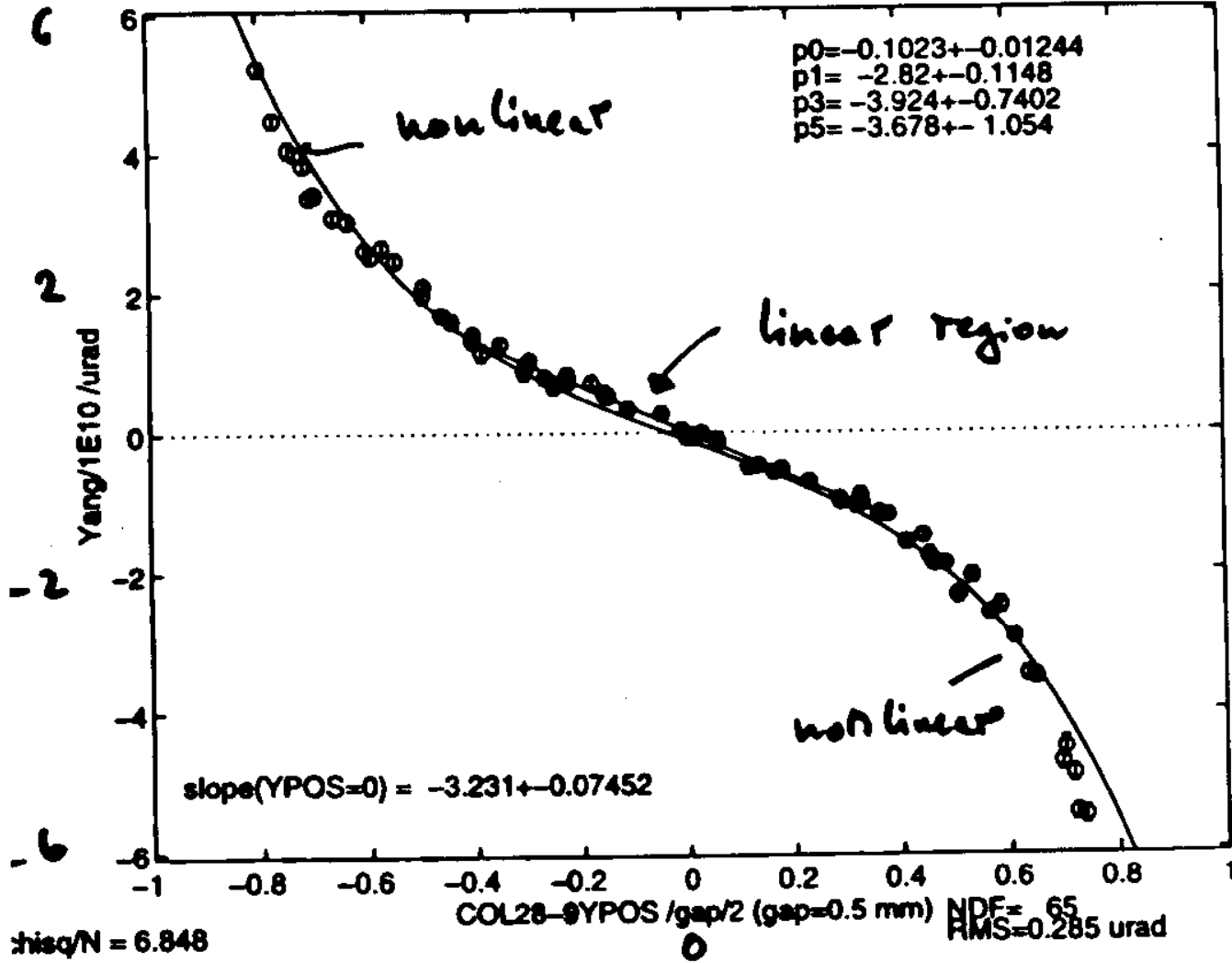

$Y_{coll}/a \rightarrow$

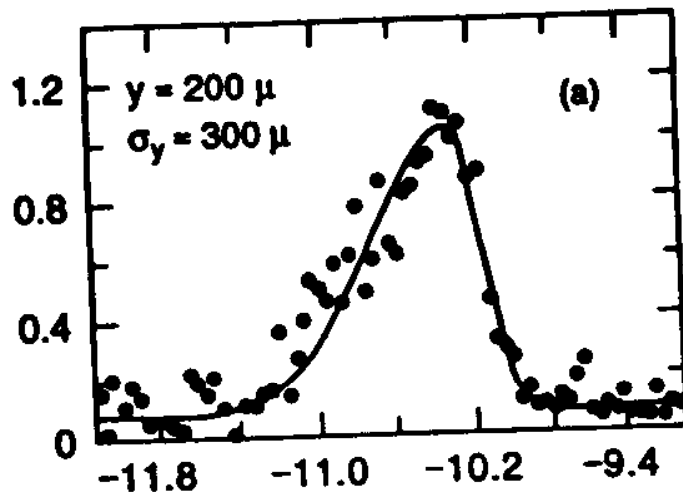

$$\Delta y = 200 \mu m$$

$$\sigma_y = 300 \mu m$$

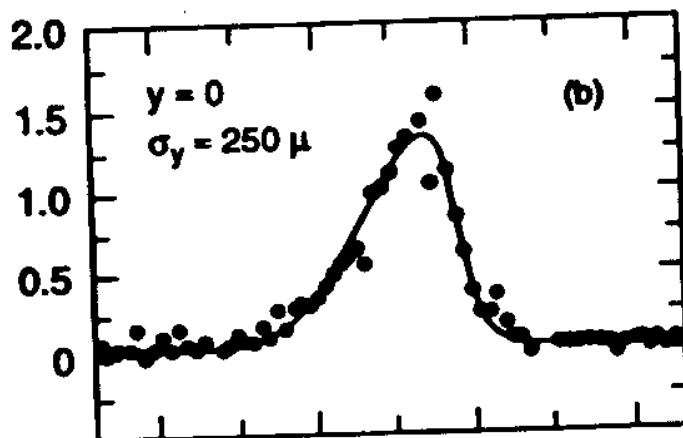

$$\Delta y = 0$$

$$\sigma_y = 250 \mu m$$

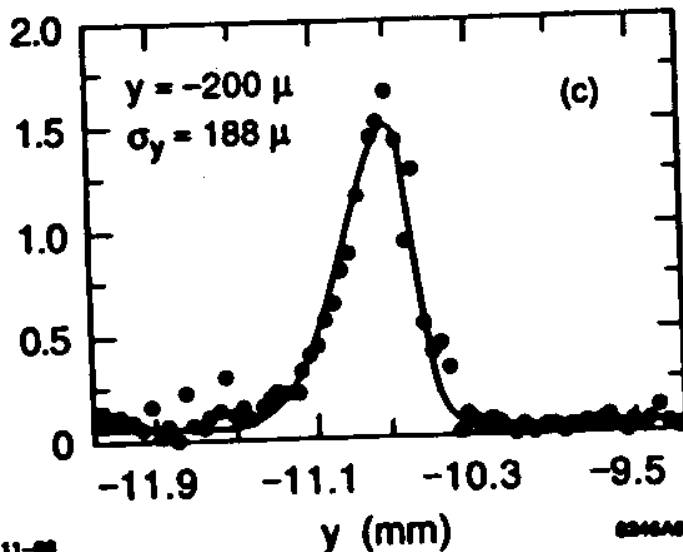

$$\Delta y = -200 \mu m$$

$$\sigma_y = 188 \mu m$$

Collimators

- **Collimator design**

Gold plated to absorb rescattered particles

!!! but High dE/dX causes overheating

Leaving nickel with irregular gold ridges

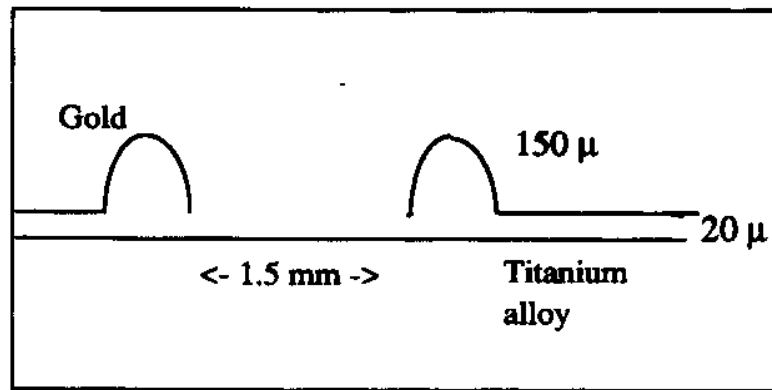

Replacing jaws of Linac Collimators

Use titanium alloy,
with ion implanted vanadium layer

Energy Collimators are badly damaged
e- low energy jaw has trough in titanium
Repair and improve cooling

**VERTICAL COLLIMATOR - SECTOR 28
SHOWING FORWARD BEAM DAMAGE**

← S 27.000 →

E. 1000

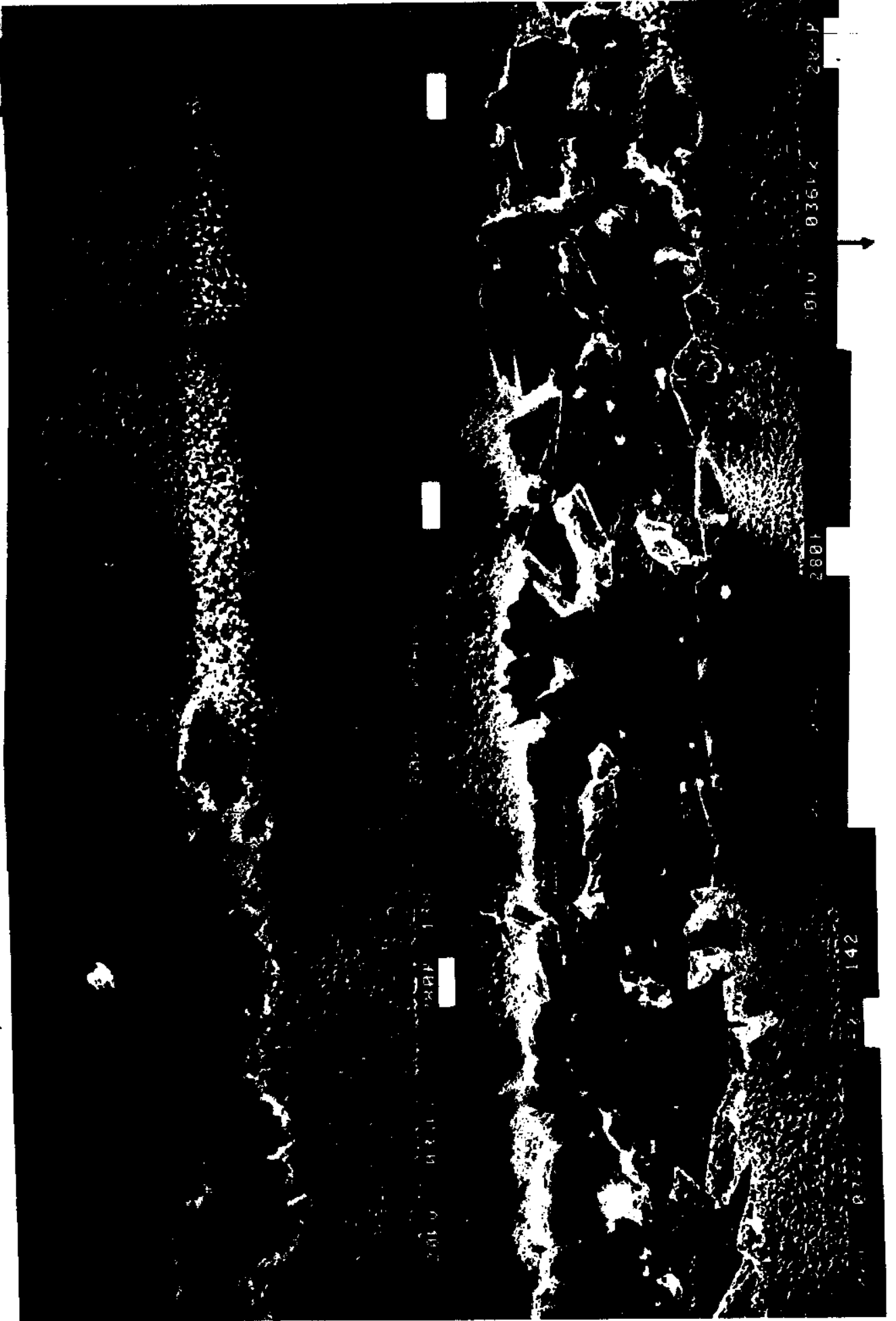

2800

2800

2800

142

2800

010

0351K

2800

Uberdevice: Plan and Elevation Views

